

Waybox Pro Waybox Plus Waybox Pro MID Waybox Plus MID

Installer Manual

ENGLISH



enel way

In this document

Purpose of this document	5
Installation Process	5
Document Structure	5
A: Hardware installation manual	7
1 Waybox	8
1.1 Features	9
1.2 Dimensions	10
2 Important safety information	11
2.1 Electric and electronic equipment end of life user's information	11
3 Package Contents	12
4 Tools Needed	13
5 Installation Prerequisites	14
5.1 Protections	16
5.2 Power and signal cables	18
5.3 JB4Installers App	18
5.4 Enel X Way App	18
6 Standard Installation	19
7 Special Installation Cases	36
7.1 Three phase Waybox installed on a Single-phase or Bi-phase supply system	36
7.2 Other special cases	36
8 Firmware Update	36
9 Load Optimization Pro	37
10 Waybox Commissioning through the Enel X Way App	38
11 Charging Test	39
11.1 Charging in Unlock to Charge mode	40
11.2 Charging in Connect&Charge Mode	41
11.3 Recording the Charging Session in the Charging history	42
11.4 Checking Charging Power	42
11.5 Testing Load Optimization Pro	42

12 LED indicator	43
B: Waymeter installation manual	44
1 Waymeter	45
1.1 Electric and electronic equipment end of life user's information	45
2 Single-phase Waymeter	46
2.1 Features	46
2.2 Installation	48
2.3 Waybox connection diagrams	52
3 Three-phase Waymeter	54
3.1 Features	54
3.2 Installation	56
3.3 Waybox connection diagrams	63
C: JB4Installer app manual	66
1 Purpose of the Manual	67
2 Pre-requisites	67
3 Login	67
4 New firmware download	69
5 Loading the Waybox serial on the app	70
6 Connecting the Waybox to the App	72
7 Firmware Update	75
8 Waybox Connectivity Check for Cellular Versions	78
9 Waybox Configuration	80
9.1 Configuration of the "Supply System" Parameter	80
9.2 Wi-Fi Configuration	81
9.3 Waymeter Configuration (for Waybox Pro)	82
9.4 Configuration of the Waybox in Standalone Mode	83
9.5 Configuration of the Waybox in Absence of Cellular Connectivity	84
9.6 Configuration of the Waybox in case of installation on the IT network or in absence of neutral	88
9.7 GPD disabling procedure	88

10 Viewing Waybox Diagnostics	89
D: Web Manager manual	90
1 Procedure for accessing the Web Manager tool	91
2 Procedure for setting the Waybox in “standalone” mode in case of lack of connectivity and for commissioning	92
3 Setting the Waybox access mode, power, and Supply System	93
4 Association of the Waybox with Waymeter	96
5 Wi-Fi	99
E: Procedure for installing the external protection release solution for Waybox with control board	100
1 Introduction	101
2 Procedure for installing the external protection release solution	101
3 Composition of Siemens Protection Kits	103
F: What-if Manual – Special installation cases	105
1 Purpose of the Manual and Method	106
2 List of Special Installation Cases	107
2.1 Data network signal with SIM is insufficient	108
2.2 Single-phase IT power grid	109
2.3 Customer smartphone connectivity not adequate	110
2.4 Lockable garage with shutter (or other type) that weakens signal	111
2.5 Single-phase TT/TN power grid	112
2.6 Three-phase TT/TN power grid	113
2.7 Single-phase TT electrical grid without neutral	114
2.8 Waybox with control board in Italy and in Holland	114
2.9 EV ready Installation	115
2.10 Waybox with Load Optimization Pro (without photovoltaics)	115
2.11 Waybox with Load Optimization Pro (with photovoltaics)	116
2.12 Customer's vehicle not available during installation	116
2.13 Renault Zoe, Smart 22 kW, Twingo Electric	117
2.14 Load Optimization Pro with transformer	117

Purpose of this document

The purpose of this manual is to provide the installer with all the information necessary for the correct installation and commissioning of the Waybox Pro and Waybox Plus charging stations.

Installation Process

The following process is recommended to carry out the installation operations:

1. Please read this Installer Manual.
2. Carry out a feasibility inspection at the installation site by filling out a checklist provided for this purpose by Enel X Way. This checklist allows you to find out whether you can proceed with standard installation (see [Standard Installation](#)) or whether you need to follow the special installation procedures (see [What-if Manual](#));
3. Obtain tools, materials, apps, and everything needed for installation (see [Tools Needed](#));
4. Proceed with installation, commissioning, configurations, testing, and acceptance test.

Document Structure

The manuals that comprise this document are listed below.

DOCUMENT SECTION	MANUAL	TOPIC
A: Hardware installation manual	Waybox Pro & Waybox Plus Installation Manual	Physical installation of the Waybox, introduction to configurations, commissioning via Enel X Way app, and charging test
B: Waymeter installation manual	Waymeter Installation Manual	Physical installation of single-phase and three-phase Waymeter device to enable Load Optimization Pro feature (available only with Waybox Pro)

C: JB4Installer app manual	Waybox4Installer App Manual	Guide for the use of the "Waybox4Installer" app, necessary to carry out the Waybox configuration activities (if not carried out with the Enel X Way app) and Waymeter
D: Web Manager manual	Web Manager Manual	Guide for the use of the "Web Manager" web app, which can be used by all users to carry out the Waybox configuration activities (if not carried out with the Enel X Way app) and Waymeter
E: Procedure for installing the external protection release solution for Waybox with control board	Procedure for installing the external protection release solution for Waybox with control board	Guide to install protection components for Waybox equipped with control board
F: What-if Manual - Special installation cases	What-if Manual - Special installation cases	Procedures to be followed after verification of a non-standard installation case

A: Hardware installation manual

1 Waybox

Waybox Pro and Waybox Plus charging stations are available in two versions.

WAYBOX CABLE VERSION (1):



1	Cable
2	RFID reader
3	LED indicator
4	Connector

WAYBOX SOCKET VERSION (2):



1	RFID reader
2	LED indicator
3	Socket

The Waybox Pro differs from the Waybox Plus by the possibility to enable the Load Optimization Pro feature, which allows the Customer to always charge at the maximum available power without triggering the meter. The activation of this function requires the installation of an additional device, the Waymeter.

- > **Waybox Pro installation:** hardware installation of the Waybox, hardware installation of the Waymeter, configuration, testing and acceptance test
- > **Waybox Plus installation:** hardware installation of the Waybox, configuration, testing and acceptance test

Waybox with control board: The cable version Waybox to be installed in Italy and Holland has the control board.

Waybox to be installed according to EV ready requirements also are equipped with the control board.

1.1 Features

Output power	Single-phase	Up to 3.7 kW, 16 A
		Up to 7.4 kW, 32 A
	Three-phase	Up to 22 kW, 32 A
Input voltage	Single-phase	230 VCA
	Three-phase	400 VCA
Charging mode	Mode 3	
LED	Dynamic LEDs indicating charging status	
Protection	IP55, IK08	
	<p>The Waybox has an internal detector for DC fault currents above 6 mA.</p> <p>The following external protections are required:</p> <ul style="list-style-type: none"> > Type A residual current device (RCD) > Curve C Miniature Circuit Breaker (MCB) 	
Operating temperature	From -30°C to +50°C (Pro & Plus) From -25°C to +50°C (Pro MID & Plus MID)	
Standards and certifications	IEC 61851-1	
	CE Certification RED 2014/53/EU	

1.2 Dimensions

NOTE:

All dimensions are in mm.

> Base (mounting holes circled in red)

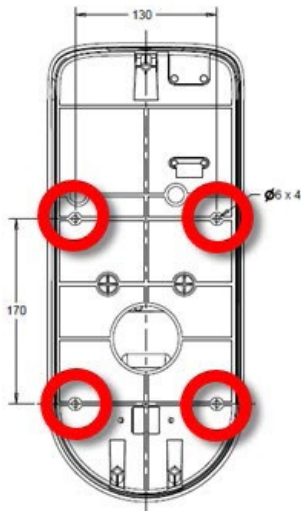

> Waybox cable version

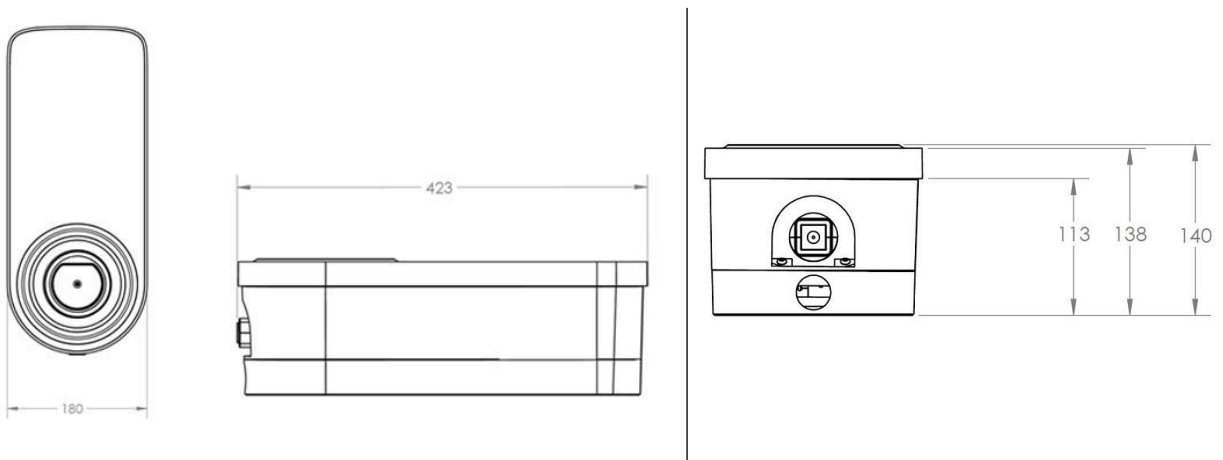

> Waybox socket version and Waybox socket version with control board

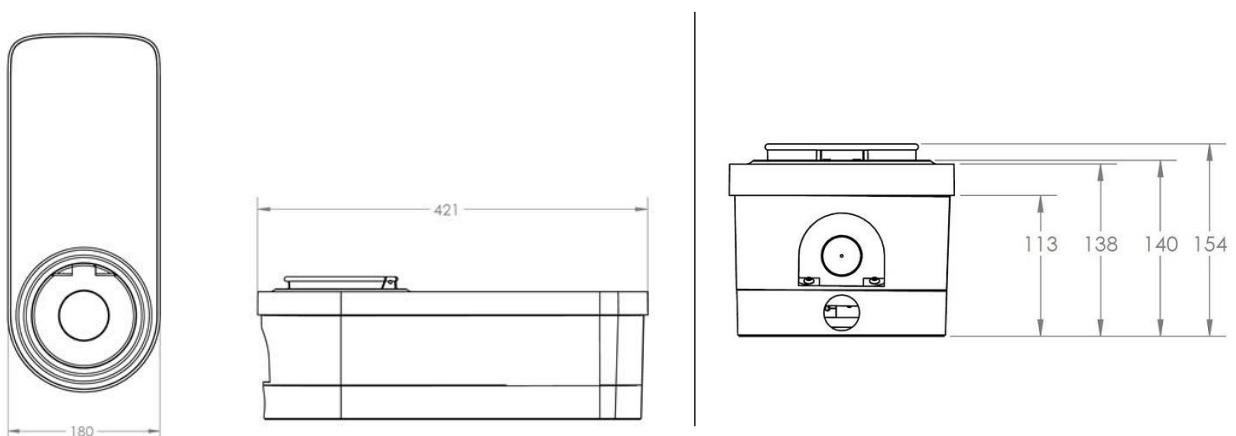

2 Important safety information

Read all safety information before installing the product.

- > **WARNING:** Do not leave this unit unattended if children are nearby.
- > **WARNING:** Do not put your fingers into the electric vehicle connector.
- > **WARNING:** Do not use this product if the flexible power cord is frayed, has damaged insulation, or shows other signs of damage.
- > **WARNING:** For use with electric vehicles only.
- > **WARNING:** Do not use this unit with an extension cord.
- > **WARNING:** Do not remove the cover or attempt to open the housing. There are no user-serviceable parts inside. Refer all servicing to qualified service personnel.
- > **WARNING:** Install and use the Waybox away from flammable, explosive, irritating, or combustible chemicals, materials, or vapors.
- > **WARNING:** Do not turn on the Waybox outside of its operating temperature range of -30°C to $+50^{\circ}\text{C}$.
- > **WARNING:** This unit is intended only for electric vehicles that do not require ventilation while charging.
- > **WARNING:** This product must be grounded. In the event of a failure or breakdown, grounding ensures a path of least resistance for electrical current to reduce the risk of electric shock.
- > **WARNING:** Improper connection of the equipment-grounding conductor may result in a risk of electric shock. If you are unsure whether the product is properly grounded, consult a qualified electrician or service technician.

2.1 Electric and electronic equipment end of life user's information





Pursuant to local laws and regulations and according to art.14 of Directive 2012/19 / EU on waste electrical and electronic equipment (WEEE), crossed-out waste bin symbol on

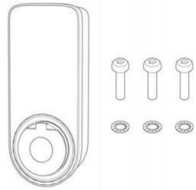
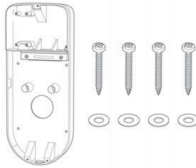
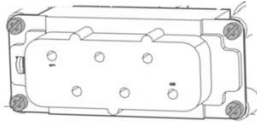

equipment or on its packaging means that the product shall be disposed of separately from household waste. When this product reaches its end of life, take it to a collection point designated by local authorities. The separate collection and recycling of product at the time of disposal will help to conserve natural resources and ensure that it is recycled in a manner that protects human health

and the environment.

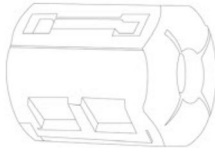
3 Package Contents

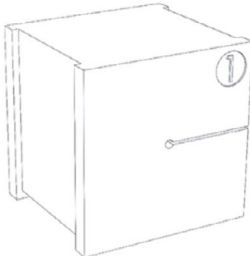
<p>Enel X Way Waybox™ charging station with M3-0.5 x 12 mm screws (x3) and washers (x3)</p>	
<p>Base with M5 x 50 mm screws (x4) and washers (x4)</p>	
<p>Terminal block</p>	
<p>Dowels M8 x 40 mm (x4)</p>	
<p>Ferrite</p>	
<p>Terminals (x5)</p> <p>NOTE: These terminals must be used only when using cables with a cross section of 4 mm² and 6 mm²</p>	
<p>Watertight gasket for external antenna</p> <p>NOTE: This item must be installed in case you need an external antenna.</p>	

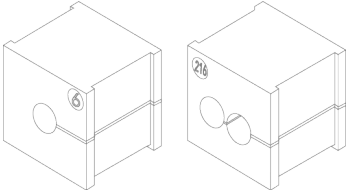
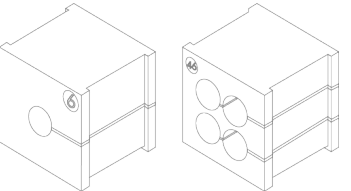
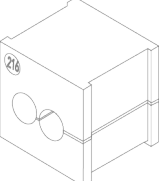
<p>Gasket kit for single-phase Enel X Way Waybox™ installation with 10 mm² cross section cables</p> <ul style="list-style-type: none"> > Gasket 6 for PE > Gasket 2/6 for L1 and N/L2 	
<p>Gasket kit for three-phase Waybox installation with 10 mm² cross section cables</p> <ul style="list-style-type: none"> > Gasket 6 for PE > Gasket 4/6 for L1, L2, L3, N 	
<p>Gasket for installation of connection cables with control board (included only in versions with control board)</p> <ul style="list-style-type: none"> > Gasket 2/3 	

4 Tools Needed

- > Phillips screwdriver.
- > Flat screwdriver.
- > Pencil or marker.
- > Hex wrench size 4.
- > Wrench size 8.
- > Phillips screwdriver (dynamometric 1.3 Nm).
- > Crimping tool.
- > Wire stripper.
- > Electrician's scissors.
- > Silicone.
- > Android smartphone (required for configuration tasks).
- > Measuring tape and level.

For masonry or concrete buildings:

- > Hammer.
- > Drill bit for M8 wall plugs.

5 Installation Prerequisites

The Waybox must be installed in accordance with the following specifications:

- > Within a useful distance of the vehicle's charging port.
- > For Wi-Fi enabled units: Within range of local Wi-Fi network (supports IEEE 802.11b/g/n at 2.4 GHz).
- > For units equipped with a cellular data connection (Waybox Pro Cellular and Waybox Plus Cellular): in an area with good mobile data network coverage. If the reception is not sufficient, an external antenna will also need to be installed and connected to the Waybox. The optimal signal strength is greater than or equal to -80 dBm (e.g. -75 dBm is greater than -80 dBm, because of the minus sign). If the measured signal is less than -80 dBm (e.g. -85 dBm) could be necessary to install a dedicated external antenna. Anyway, also if an antenna is installed it could not be sufficient.

DEVICE	NOTE	POWER/OPERATING BANDS
Wi-Fi	IEEE 802.11 b	17 dBm (50mW)
	IEEE 802.11 g	13 dBm (20mW)
	IEEE 802.11 n	12 dBm (15mW)
	Operating bands	2400 – 2483,5 MHz
RFID	RF Power	27dBm (0.5W)
	Operating bands	Fo: 13,56 MHz; bandwidth: 2,26 kHz

Cellular	2G	LB Class 4 33dBm (2W)
	2G	LB Class E2: 27dBm (0.5W) @ EDGE
	2G	HB Class 1: 30dBm (1W)
	2G	HB Class E2: 26dBm (0.4W) @ EDGE
	3G (WCDMA)	Class 3: 24dBm (0.25W)
	4G (FDD & TDD)	Class 3: 23dBm (0.2W) @ 1RB
	Operating bands	B28A: 703 – 788 MHz B20: 791 – 862 MHz B8: 880 – 960 MHz B3: 1710 – 1880 MHz B1: 1920 – 2170 MHz B7: 2500 – 2690 MHz

The Waybox is compatible with the networks in the following table:

DISTRIBUTION		NEUTRAL	VOLTAGE
Single-phase	TT	Yes	230 VAC
Three-phase		Yes	400 VAC
Single-phase	TN-S TN-C-S	Yes	230 VAC
Three-phase		Yes	400 VAC
Single-phase	IT	No	230 VAC

NOTE: Waybox MID version is not compatible with IT grid

NOTE:

The system shall be installed in accordance with applicable local codes.

 **WARNING**

Some electric vehicles require the Neutral (N) on the charging station to have direct contact with the Ground. This has an impact on charging in case of IT networks. In this case, a transformer must be installed upstream of the RCD and MCB and the Waybox to have a local TN system.

5.1 Protections

The installation of the Waybox should include dedicated protection devices. Below are the recommended protections for the installation:

WAYBOX		MINIATURE CIRCUIT BREAKER	RESIDUAL CURRENT DEVICE
Single-phase	Up to 3.7 kW, 16 A	<ul style="list-style-type: none"> > Curve C > ICC: 10 kA > In: 20 A > Poles: 2 	<ul style="list-style-type: none"> > Type A > Id: 30 mA > In: 20/25 A > Poles: 2
	Up to 7.4 kW, 32 A	<ul style="list-style-type: none"> > Curve C > ICC: 10 kA > In: 40 A > Poles: 2 	<ul style="list-style-type: none"> > Type A > Id: 30 mA > In: 40 A > Poles: 2
Three-phase	Up to 22 kW, 32 A	<ul style="list-style-type: none"> > Curve C > ICC: 10 kA > In: 40 A > Poles: 4 	<ul style="list-style-type: none"> > Type A > Id: 30 mA > In: 40 A > Poles: 4

NOTE:

MCB shall have a magnetic throughput energy $I^2 t \leq 60000 \text{ A}^2 \text{ s}$

WAYBOX WITH CONTROL BOARD

Waybox with control board are equipped with a clean contact on the board itself that changes its status from NO (normally open) to closed in case of a fault on the internal contactor of the Waybox. In this case, the control board is used to command the opening of a protection (differential or magnetothermal) to cut off the power supply circuit.

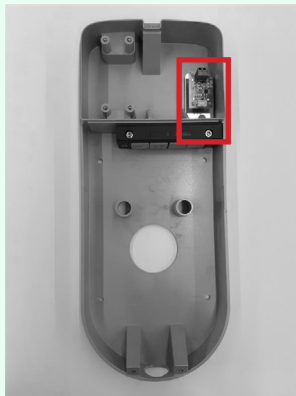

Control board location



Clean contact on control board

The characteristics of the clean contact of the control board are as follows:

- > The contact is NO (normally open).
- > The maximum voltage the contact can withstand is 60V.
- > The maximum sustained current in continuous mode is 100 mA.
- > The cross-section of the connecting cables to the contact is between 1 mm² and 1,5 mm².
- > The diameter of the connecting cables is between 3 mm and 3.5 mm.

The change in status of this contact is used to control an external release solution (motor with MCB adapter). For more information on the installation of the release device, please refer to [“Procedure for installing the release solution for external protections for Waybox cable version and socket version with control board”](#).

5.2 Power and signal cables

The choice of cross-sections, insulating materials and composition of the power cables shall be made in line with the size of the switches and in accordance with local standards in force.

The following table shows the minimum recommended cross sections for a standard installation using copper cables.

WAYBOX		MINIMUM SECTION
Single-phase	Up to 3.7 kW, 16 A	4 mm ²
	Up to 7,4 kW, 32 A	6 mm ²
Three-phase	Up to 22 kW, 32 A	6 mm ²

NOTE:

The maximum conductor cross-section of cables that can be used for Waybox is 10 mm². In this case the maximum conductor diameter shall be 4 mm.



WAYBOX WITH CONTROL BOARD:

Waybox with control board require signal cables with section between 1 and 1.5 mm² and external diameter between 2.5 and 3.5 mm.

5.3 JB4Installers App

Enel X Way partners will need to install the JB4Installers app on their smartphone to perform Waybox configuration and diagnostic tasks. To use the app, they will need to receive authorization from Enel X Way and complete a registration process. Please refer to the [JB4Installers App Manual](#) for more information.

5.4 Enel X Way App

Enel X Way partners will need to install the Enel X Way app on their smartphone to perform Waybox configuration tasks. Enel X Way app is available on the [iOS App Store](#) e [Google Play](#). For more information, see [section 10](#) of this manual.

6 Standard Installation

The following is the standard installation procedure, valid for all versions of Waybox in this manual. The procedure also includes optional steps, which must be carried out only in the following cases:

- > Installation of a Waybox with control board.
- > Installation of an external antenna.

NOTE:

The Waybox must be installed by a qualified electrician.

1. Make sure no voltage is applied to the input cable.

WARNING

Do not continue this procedure until you are certain that no voltage is present at the input cable.

2. When installing 4 mm² and 6 mm² cross-section cables, install the terminals on the input cable wires with the crimping tool.

NOTE:

When installing 10 mm² cables, strip only the cables, do not install the terminals.





3. Remove the gasket block cover using a 4mm hex wrench.



4. Identify the nut screws that secure the gasket block. Hold the nut in place with a size 8 wrench, then loosen the screw with a size 4 hex wrench.





For the screw on the left, the nut is located behind the base:



NOTE:

It is not necessary to remove the fastener altogether, as it will be retightened later.

5. Remove the 2 perforated gaskets from the block.

NOTE:

These gaskets have a printed code to identify the hole diameter. Gaskets with a single hole have a single digit that identifies the hole diameter in mm. Multi-hole gaskets have 2 digits: the first digit identifies the number of holes, the second digit identifies the hole diameter (e.g. 2/6, gasket with 2 holes 6 mm in diameter).



NOTE:

These gaskets must be replaced according to the type of installation as shown in the table below:

TYPE OF INSTALLATION	GASKET REQUIREMENTS
Single-phase Waybox installation with cables up to 6 mm²	Do not replace gaskets
Three-phase Waybox installation with cables up to 6 mm²	Do not replace gaskets
Single-phase Waybox installation with 10 mm² cables	<ul style="list-style-type: none"> > Replace gasket 5 with gasket 6 > Replace gasket 2/4 with gasket 2/6
Three-phase Waybox installation with 10 mm² cables	<ul style="list-style-type: none"> > Replace gasket 5 with gasket 6 > Replace gasket 4/4 with gasket 4/6
Three-phase Waybox installation in single-phase mode with cables up to 6 mm²	<ul style="list-style-type: none"> > Replace gasket 4/4 with gasket 2/4
Three-phase Waybox installation in single-phase mode with 10 mm² cables	<ul style="list-style-type: none"> > Replace gasket 5 with gasket 6 > Replace gasket 4/4 with gasket 2/6

ONLY IN CASE OF EXTERNAL ANTENNA INSTALLATION:

Remove also the third gasket (without holes) from the block. A single hole gasket, contained in the package, will be installed in place of this one.

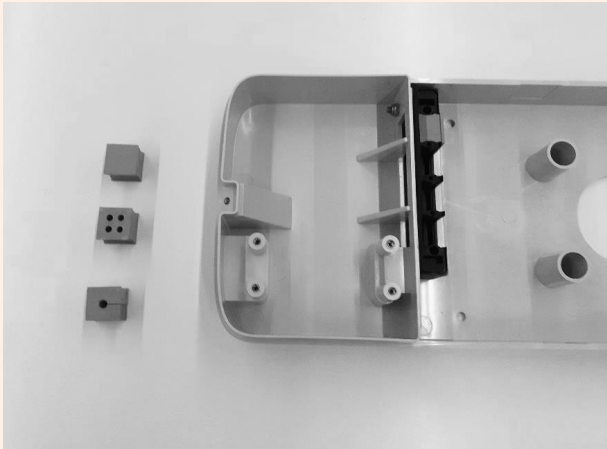

6. Place power cables and other signal cables (external antenna cable or signal cables in case you are installing a cable version and socket version with control board Waybox), if any, in the appropriate holes.

NOTE:

Do not secure the base at this stage.



> For concealed
input cables



> For non-concealed
input cables

7. Arrange the input wires through the gaskets:

- > **1-hole gasket:** grounding wire.
- > **2- or 4-hole gasket:** conductors (phase and neutral) The position of the individual conductors in the gasket is not relevant. In the case of single-phase installation on 4-hole gaskets, an appropriate closing plug must be inserted into the empty gaskets.

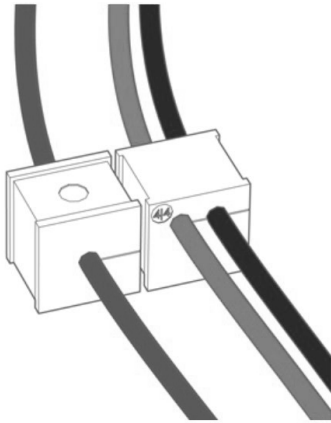

Single-phase installation

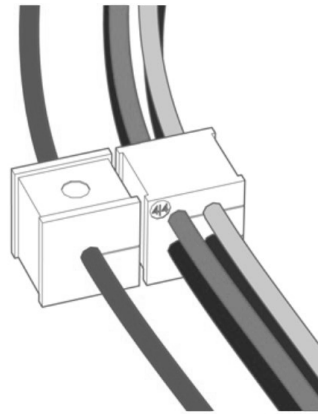

Three-phase installation

ONLY IN THE CASE OF INSTALLATION OF A WAYBOX WITH CONTROL BOARD:

Run the two connection cables of the clean contact through the dedicated two-hole grommet.

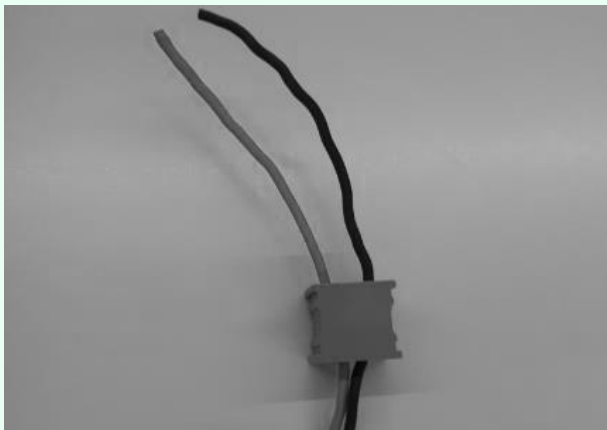

The clean contact connection cables are used to bring the control signal to the protection panel and control the release solution.

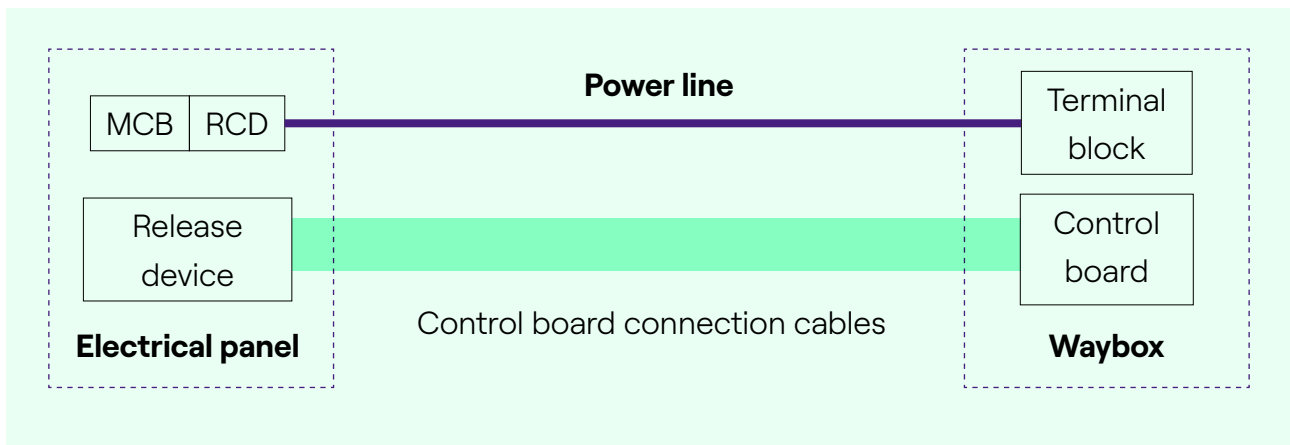

FOR OUTDOOR ANTENNA INSTALLATION ONLY:

Route the cable through the included grommet.



8. Route the power cords through the partition in the upper section of the housing, as shown.

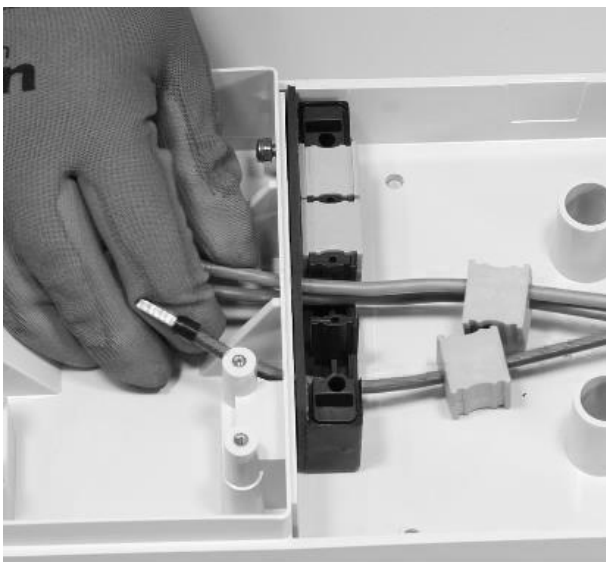

FOR INSTALLATION OF A WAYBOX WITH CONTROL BOARD ONLY:

Run the two clean contact connection cables through the partition in the upper section of the housing, as shown.

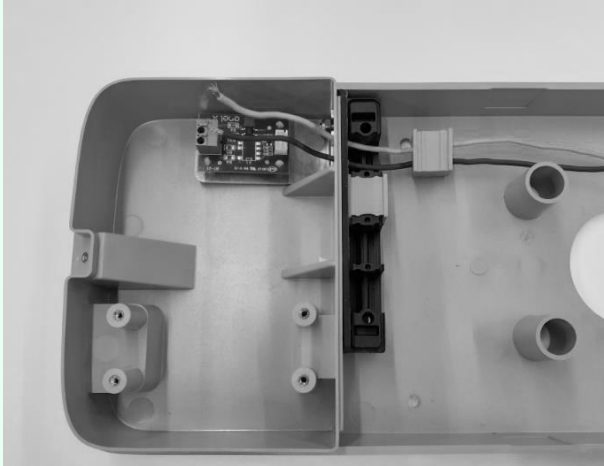

FOR EXTERNAL ANTENNA INSTALLATION ONLY:

Also route the antenna cable through the partition in the top section of the housing, as shown.

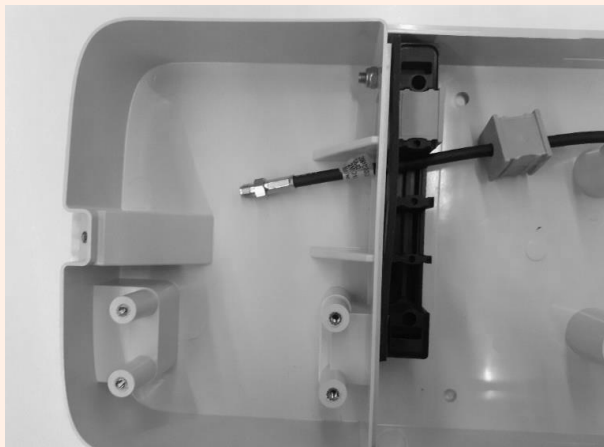

9. Pull the wires as far as possible into the top section of the housing, then install the gaskets into the block.

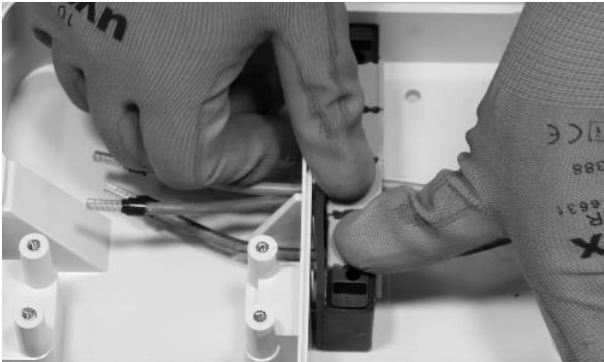

ONLY FOR THE INSTALLATION OF A WAYBOX WITH CONTROL BOARD:

Install also the gasket that houses the two connection cables to the dry contact. Also install the two connection cables (red and black) to the clean contact as shown in the figure.

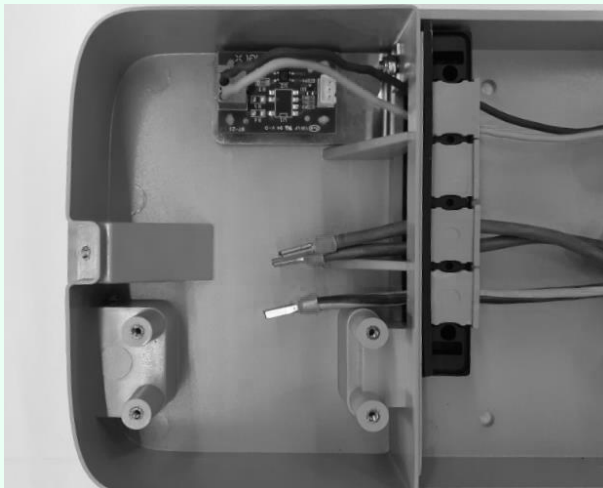

FOR OUTDOOR ANTENNA INSTALLATION ONLY:

Also install the gasket that houses the coaxial cable extension.



10. Attach the gasket block to the base, using an 8mm wrench to hold the nut in place while tightening the screw with a 4mm hex wrench (see step 5).

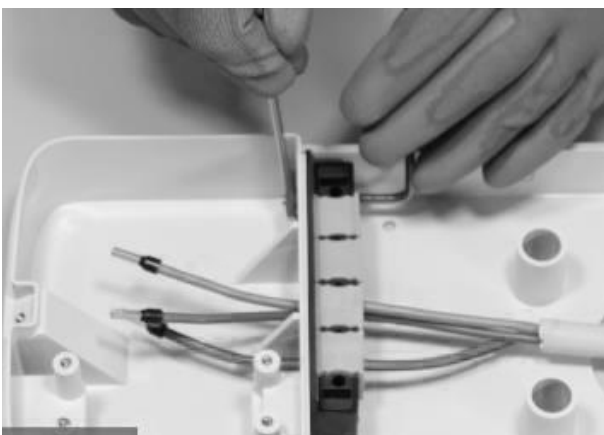
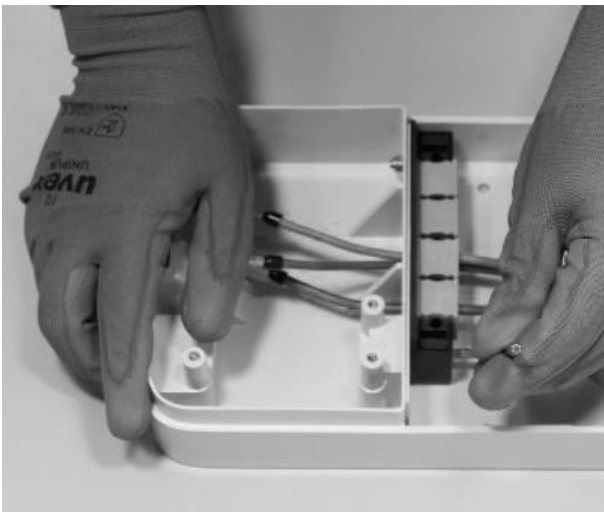

11. Install the gasket block cover (x2) with the size 4 hex key (see step 4).

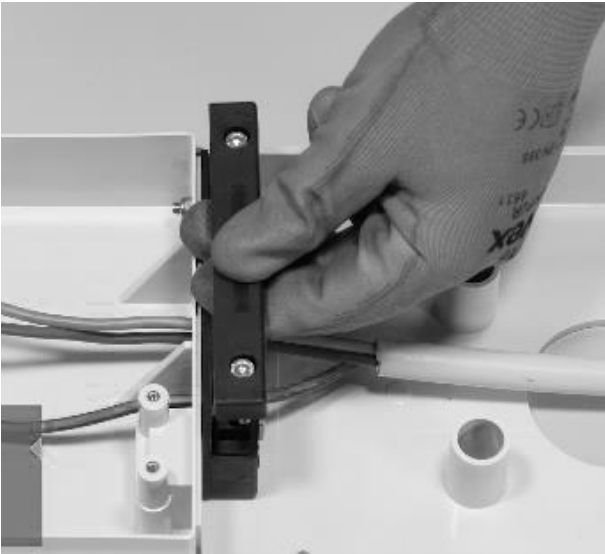

12. Install the ferrite around the power cables at the base of the gasket block.

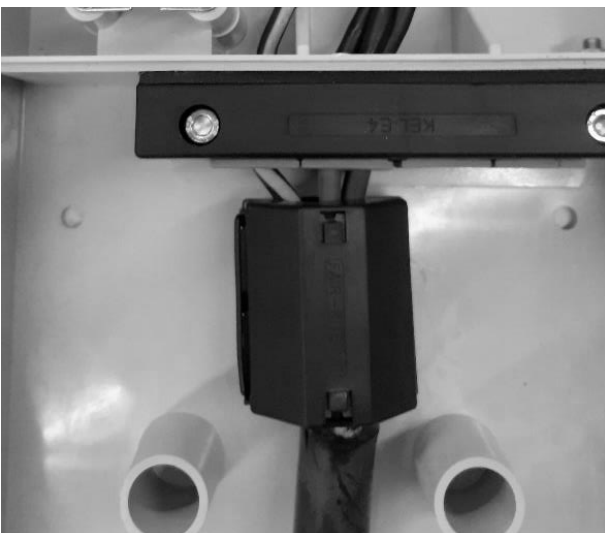

In case of external antenna installation, it is not necessary to include the antenna cable inside the ferrite.

13. Loosen the terminal screws on the sides of the terminal block (x6). Install the wires into the terminal block. Make sure each wire snaps into place, then tighten the corresponding screw.



⚠ WARNING
 In case of single-phase installation the voltage between L1 and L2/N must be max 230 V.

POSITION IN THE TERMINAL BLOCK	SINGLE-PHASE INSTALLATION	THREE-PHASE INSTALLATION
1	Neutral/L2	Neutral
2	Ground	Ground
3	L1	L1
4	Not used	L2
5	Not used	L3
6	Not used	Not used

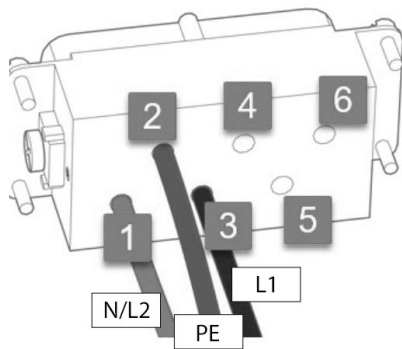
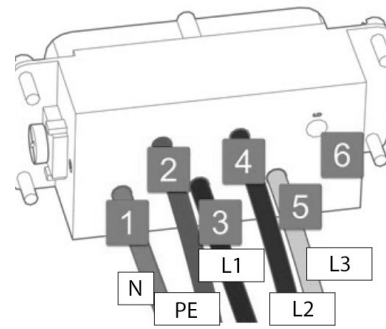
**Single-phase installation****Three-phase installation****NOTE:**

In case of installation of cables with section 10 mm², the installer must insert the conductors with due accuracy, verifying that they are properly arranged and inserted, i.e. that the copper of the cable enters completely into the terminal, that the insulating sheath enters the "drop" of the plastic insert and operating without excessive strain.



14. Perform a pull test to check that the wires are secure.

15. Secure the terminal block with the Philipps screwdriver.

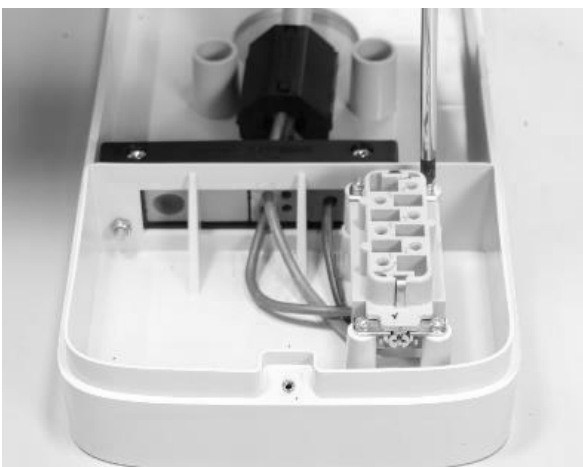

16. Place the base in the desired position at a height of at least 90 cm between the floor and the bottom edge of the base. While holding the base steady, use the 4 mounting holes as a guide to mark the points to be drilled in the wall.



17. Using an 8 mm drill bit, drill 50 mm deep holes in the previously marked locations on the wall. Install the 4 wall plugs.



18. Use the screws and washers to install the base.



ONLY WHEN INSTALLING AN EXTERNAL ANTENNA:

Also disconnect the internal antenna from the connector on the back of the Waybox allowing the cable to hang freely. Connect the external antenna cable to the connector on the back of the Waybox.

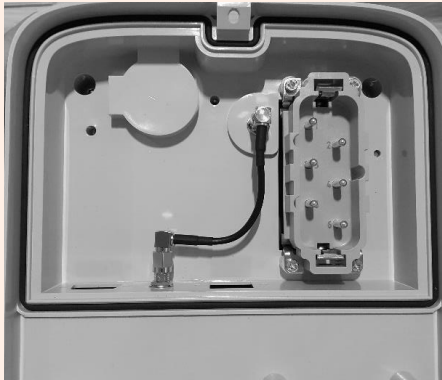
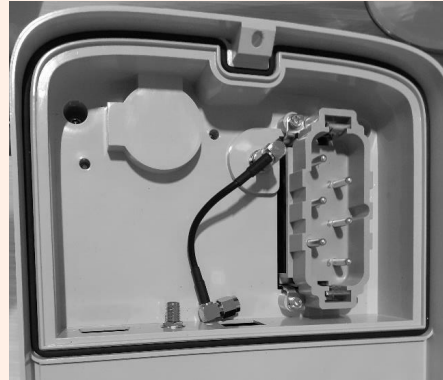
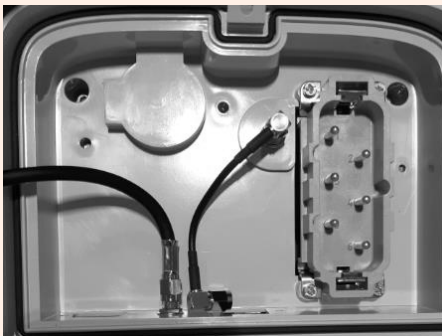
**Connecting internal antenna****Disconnecting internal antenna****Connecting external antenna cable**

Only for the installation of a Waybox with control board, before securing the Waybox on the base, connect the connection cable coming out of the Waybox case to the header of the board with clean contact as shown in the picture.

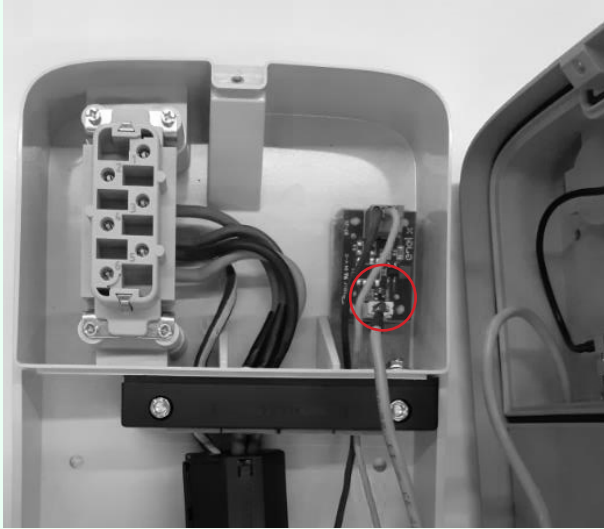

19. Install the Waybox on the base. Use the washers and fastening screws (2 at the bottom, 1 at the top) that secure the Waybox to the base (use torque wrench 1.3 Nm).



20. Apply voltage to the power cord. Check that the LED indicator of the Waybox turns solid purple within two minutes.

7 Special Installation Cases

7.1 Three phase Waybox installed on a Single-phase or Bi-phase supply system

In the case of installation of a three-phase Waybox on a Single-phase or Bi-phase supply system **it is mandatory** to set up the parameter "Supply system" after the Firmware Update and prior to commissioning of the Waybox. The supply system must be configured as:

- > "Monophase" in case of installation on a single-phase supply system ($V_{ph}=230\text{ V}$, $V_n=0$)
- > "Biphase" in case of installation on a bi-phase supply system ($V_{ph1}=127\text{ V}$, $V_{ph2}=127\text{ V}$) through one of the following methods:
 - > Configuration of the "Supply System" parameter through the "JB4Installers" smartphone app (reserved for Enel X Way partners). To proceed with the configuration please refer to the [JB4Installer App Manual](#).
 - > Configuration of the "Supply System" parameter through the "Web Manager" Web App (usable by all users). To proceed with the configuration please refer to the [Web Manager Manual](#).

7.2 Other special cases

Should the installer verify the presence of one of the special cases indicated in the [What-if manual](#), please refer to the procedure defined for the specific case described in the same manual.

8 Firmware Update

Once the Waybox is installed, it is necessary to perform a firmware update using the JB4Installers app. To do this, it is necessary to:

- > Make sure you have the JB4Installers app installed on your smartphone and the necessary credentials to log in.
- > Download the latest available firmware.
- > Add the serial number of the Waybox in the app.
- > Proceed with updating the Waybox firmware.

For the detailed procedure, please refer to the [JB4Installers App Manual](#).

9 Load Optimization Pro

NOTE:

The information in this paragraph, and the instructions in the linked manuals, should only be considered if the Load Optimization Pro feature is scheduled to be activated for the Customer. Only Waybox Pro and Waybox Pro Cellular allow Load Optimization Pro to be activated.

This feature allows the Waybox to adapt its power level based on the consumption of other devices connected to the same power line. In this way, it is possible to charge at the maximum available power while avoiding the risk of triggering the meter.

The Waymeter device must be installed to use this feature. In the case of Waybox Plus and Waybox Plus Cellular, since this feature is not available, the Waymeter device will not be installed.

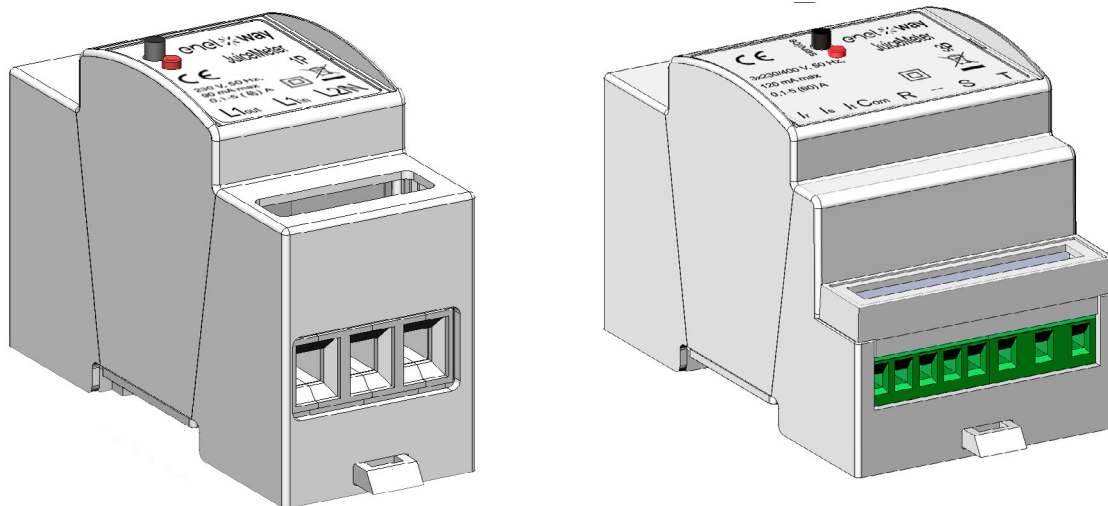

To install this device, please refer to the [Waymeter Installation Manual](#) and follow the relevant procedure depending on whether the device is single-phase or three-phase.

Configuration tasks can be performed in one of the following ways:

- > Configuration of the Waybox and Waymeter through the "JB4Installers" smartphone app (reserved for Enel X Way partners). To proceed with the configuration please refer to the [JB4Installers App Manual](#).
- > Configuration of the Waybox and Waymeter through the "Web Manager" Web App (usable by all users). To proceed with the configuration please refer to the [Web Manager Manual](#).

10 Waybox Commissioning through the Enel X Way App

1. Enel X Way partner can install the app of Enel X Way on his/her device by scanning QR code below.



2. Once the Enel X Way Waybox™ has been installed, the Enel X Way partner must associate it with his/her Enel X Way app account in the **Waybox** section of the main page of the app and following the instructions on the screen.
3. After pairing the Enel X Way Waybox™ with its Enel X Way app account, the Enel X Way partner must proceed to unpair it from the same, otherwise the Customer will not be able to associate the Waybox on his/her account.. The Enel X Way partner can dissociate the **Waybox** from their account by access Waybox section of the main page of the app and by clicking on **setting icon > unpair**.

NOTE: To use the Enel X Way app, the charging station must be connected online and the phone on which the app is installed must have Internet connectivity available.

NOTE: In case of installation of a three-phase Waybox in single-phase mode, before commissioning the Waybox, it will be necessary to perform the configuration presented at [paragraph 7.1](#).

NOTE (Waybox Pro and Waybox Pro Cellular): If a Waymeter is installed to enable the Load Optimization Pro feature, the maximum power delivered by the Waybox will correspond to the minimum between the power limit configured during Waymeter installation and the power level selected through the Enel X Way app.

11 Charging Test

Once the Waybox is installed, you can test your first charge via EV, if available.

It will be necessary to verify the operation of the station in the Connect&Charge and UnlockToCharge modes and the actual maximum power configuration described in the Waybox user manual.

NOTE:

If there is no Waybox connectivity, the allowed mode will be Connect&Charge.

The following table shows the tests to be performed in relation to whether there is any connectivity or none.

	WAYBOX CONNECTED	WAYBOX NOT CONNECTED
Charging in Unlock To Charge mode, with charging session started from Enel X Way app	X	
Charging in Unlock To Charge mode, with charging session started from RFID card (if RFID card available)	X	
Charging in Connect&Charge mode	X	X
Verify that the charging session is correctly recorded in the Enel X Way app charging history	X	
Checking Charging Power	X	X
Check correct operation in case of Load Optimization Pro	X	X

11.1 Charging in Unlock to Charge mode

This section describes how to charge a vehicle using the Waybox in Unlock To Charge mode, using the Enel X Way app or an RFID card.

NOTE:

This mode is suggested when the Waybox is installed in areas with public access or for use of the Scheduled Charging feature.

In Unlock To Charge mode, the Waybox charges only after recognizing an authorized user. Charging sessions are then started and stopped using an authorized profile on the Enel X Way App or an RFID card paired with the Waybox.

CHARGING USING THE ENEL X WAY APP

To start charging, open the **Waybox** section and **TAP TO CHARGE**.

Connect the vehicle within 90 seconds of unlocking.

- > Cable version: Connect the Waybox cable to the vehicle;
- > Socket version: Connect the charging cable to the socket on the Waybox and the vehicle.

Charging begins automatically. Once started, you can monitor the charging session on-screen.

To stop charging select **STOP CHARGING**. Charging stops automatically and the charging cable can be removed.

NOTE:

You can also stop charging sessions from the vehicle.

CHARGING USING AN RFID CARD (IF AVAILABLE)

The Enel X Way app card only allows you to start the Waybox charging session if:

- > the Waybox has been paired with the Enel X Way app account
- > the "Unlock to Charge" charging mode has been selected.
- > the Enel X Way app card has been paired with the Enel X Way app account.

To start charging, bring the card close to the Waybox RFID reader. Connect the vehicle within 90 seconds of authorizing the RFID card:

- > Cable version: Connect the Waybox cable to the vehicle;
- > Socket version: Connect the charging cable to the socket on the Waybox and the vehicle. Charging begins automatically. Through the Enel X Way app, you can track your charging sessions. To do this, access the **Waybox** section.

To stop charging, bring the card again close to the Waybox RFID reader. Charging stops automatically and the charging cable can be removed.

NOTE:

You can also stop charging by sending a stop command (from the Enel X Way app or vehicle).

11.2 Charging in Connect&Charge Mode

This section describes how to charge a vehicle using the Waybox in Connect&Charge mode.

NOTE:

This mode is suggested when the Waybox is installed in a private area.

This mode does not require any authentication to start or stop a recharge. In this mode, you cannot set scheduled charging sessions.

Waybox is set to operate in Connect&Charge mode when it is first started. However, it is recommended that you carry out the steps for commissioning the Waybox via the Enel X Way app (see [paragraph 10](#) of this manual) in order to remotely manage charging, configure Waybox settings and other parameters

To start charging, connect the vehicle to the Waybox:

- > Cable version: Connect the Waybox cable to the vehicle;
- > Socket version: Connect the charging cable to the socket on the Waybox and the vehicle.

Charging begins automatically. Through the Enel X Way app, you can track your charging sessions. To do this, access the **Waybox** section..

To stop charging, send a stop command from the vehicle, then disconnect the vehicle from the Waybox.

11.3 Recording the Charging Session in the Charging history

To view the log of charging sessions performed in the Enel X Way app, select the **History** section from the Enel X Way app menu. The list of all charging sessions performed will appear, from which you can verify the correctness of charging data.

11.4 Checking Charging Power

From the Enel X Way app, you can check during charging that the power delivered by the Waybox corresponds to the power actually set.

NOTE:

Please wait at least two minutes from the start of charging to see the correct data.

11.5 Testing Load Optimization Pro

If the Load Optimization Pro feature (available only for Waybox Pro and Waybox Pro Cellular) is activated a test must be carried out to verify its effective operation. This can be done by turning on other electrical equipment (e.g. appliances with power absorption in the order of 1 kW) in the electrical system during the test, verifying that charging occurs without exceeding the contracted power of the user and that the power available for charging is modulated correctly.

12 LED indicator

COLOR	MEANING
White	<ul style="list-style-type: none"> > Fixed: Online > Flashing (lasts 90 seconds): Online, waiting for cable to be inserted
Purple	<ul style="list-style-type: none"> > Fixed: Offline > Flashing (lasts 90 seconds): Offline, waiting for cable to be inserted
Green	<ul style="list-style-type: none"> > Fixed (duration three seconds): Start/stop command received from App or RFID card > Flashing: Charging
Yellow	<ul style="list-style-type: none"> > Flashing: Standby <p>The Waybox may be in "standby" mode for several reasons:</p> <ul style="list-style-type: none"> > Due to the vehicle (e.g. charged battery, high battery temperature, interruption of charging on vehicle side) > Due to Waybox (e.g. set Smart Charging profile, current available from Load Optimization < 6 A)
Red	<ul style="list-style-type: none"> > Fixed (lasts three seconds): Unauthorized RFID card or cable insertion time expired > Lampeggiante: Error
Blue	<ul style="list-style-type: none"> > Temporary: Waybox being turned on or restarted > Fixed: software error, Waybox to be replaced

B: Waymeter installation manual

1 Waymeter

Waymeter is an energy meter that communicates with Waybox to enable the Load Optimization Pro feature.

After pairing the two devices, Waymeter allows Waybox to adapt its power level based on the consumption of other devices connected to the same power line. In this way, it is possible to charge at the maximum available power while avoiding the risk of triggering the meter.

The Waymeter is available in single-phase and three-phase versions. Both products are available in standard and IT GRID versions depending on the type of installation.

SINGLE-PHASE WAYMETER	Standard version
	IT GRID version
THREE-PHASE WAYMETER	Standard version
	IT GRID version

1.1 Electric and electronic equipment end of life user's information



Pursuant to local laws and regulations and according to art.14 of Directive 2012/19 / EU on waste electrical and electronic equipment (WEEE), crossed-out waste bin symbol on equipment or on its packaging means that the product shall be disposed of separately from household waste.

When this product reaches its end of life, take it to a collection point designated by local authorities. The separate collection and recycling of product at the time of disposal will help to conserve natural resources and ensure that it is recycled in a manner that protects human health and the environment.

2 Single-phase Waymeter

STANDARD VERSION	IT GRID VERSION
<p>Suitable for installation in the following types of system:</p> <ul style="list-style-type: none"> > TT, TN, TN-S, TN-C, TN-C-S, IT with neutral 	<p>Suitable for installation in the following types of system:</p> <ul style="list-style-type: none"> > TT, TN, TN-S, TN-C, TN-C-S, IT.

2.1 Features

- > **Dimensions (W x H x D):** 1.4 in/36.3 mm x 3.6 in/90.5 mm x 2.4 in/62 mm (excluding DIN rail spring)
- > **No. of DIN modules:** 2
- > **Weight:** 120 g
- > **Degree of protection:** IP20 (when the Waymeter is installed in an electrical cabinet with terminals covered by panels)
- > **Plastic housing material:** PC/ABS
- > **Flammability rating of housing:** UL94 V-0

OPERATING CONDITIONS:

- > **For Indoor use;**
- > **Operating temperature:** -20 ÷ +50 °C
- > **Storage temperature:** -30 to +70 °C
- > **Relative humidity:** 5% ÷ 95% not condensed
- > **Altitude:** ≤ 4000 m
- > **Overvoltage class:** II
- > **Pollution degree:** 2
- > **Insulation class:** II



Product distributed by Enel X Way, Via Ostiense 131L, 00154, Rome, Italy

POWER SUPPLY:> **Connection:**

- > Standard version: The device is powered between terminals "Lin" and "N", which are also used for voltage measurement.
- > IT Grid version: The device is powered between terminals "L1in" and "L2/N", which are also used for voltage measurement.

> **Nominal voltage:** 230 Vac

> **Voltage operating range:** -20%/+15% of the nominal voltage

> **Frequency:** 50 Hz

> **Power consumption:** 90 mA max

> **Internal protections:** Integrated fuse (F1: T1A 300V) not replaceable. If the fuse is tripped, the device switches off and dynamic load modulation is lost.

CONNECTION:

> **Connectors:** Three-way terminal

> **Dimensions (min ÷ max):** 2.5 ÷ 10 mm²/ 12AWG ÷ 6AWG (see paragraph 2.2 "Installation" of this manual, point 4 "Wiring")

WI-FI / BLUETOOTH CONNECTIVITY (CURRENTLY NOT AVAILABLE):

> **Functionality:** for optional configuration via APP

> **Antenna:** integrated

> **Frequency:** 2.4 GHz

> **Standard:** 802.11 b/g/n

PLC NARROW BAND COMMUNICATION (CHAIN 2):

> **Modem:** C-Band, B-PSK Modulation

> **Application:** DLMS/COSEM IEC (IEC 62056-5-3)

> **Data Model:** COSEM Data Model (IEC 62056-6-1, IEC 62056-6-2)

> **Coupling:**

> Standard version: The PLC transmission is coupled in differential mode between terminals "Lin" and "N"

> IT GRID version: The PLC transmission is coupled in differential mode between terminals "L1in" and "L2/N"

USER INTERFACE:

- > **Service LED:** service indicator (red)
- > **Button:** for initial configuration and reactivation of the device

REFERENCE REGULATIONS:

- > **Art. 3.1a Safety:** EN 61010-1:2010/A1: 2010, EN 61010-2-30:2010
- > **Art. 3.1b EMC:** EN 55032:2015/A11:2010, EN 55035:2017/A11:2010, EN 61000-3-2:2019, EN 61000-3-3:2013/A1:2019, ETSI EN 301 489-1 V2.2.3 (2019), ETSI EN 301 489-17 V3.2.2
- > **Art. 3.2 Radio:** ETSI EN 300 328
- > **Health:** EN 62311

2.2 Installation

Install the Waymeter downstream of the distributor's meter and the main circuit breaker to enable measurement of total consumption (see diagram below). The protection and disconnection device of the Waymeter will be the general MCB.

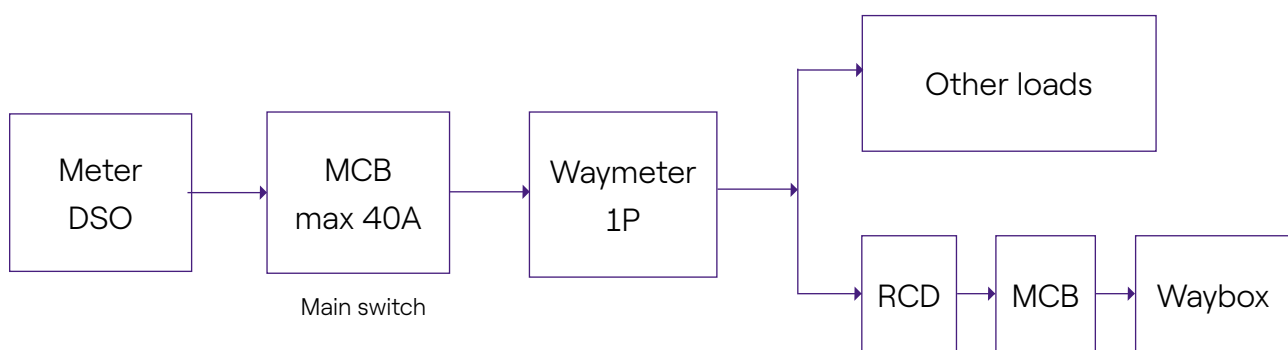

1. Read the Safety Warnings manual inside the packaging.
2. Install the product in an electrical cabinet that is accessible only to qualified personnel.
3. DIN rail mounting.
 - > The product must be installed in a vertical position on a 35mm DIN rail, with the screw terminal facing downwards.
 - > Leave at least 30mm of space above and below the Waymeter, and at least 10mm of space to the right and left of the product in relation to adjacent DIN modules, to ensure proper heat dissipation.
 - > It is not recommended to install the product close to heat sources. If necessary, maintain adequate distance between the Waymeter and such heat sources.

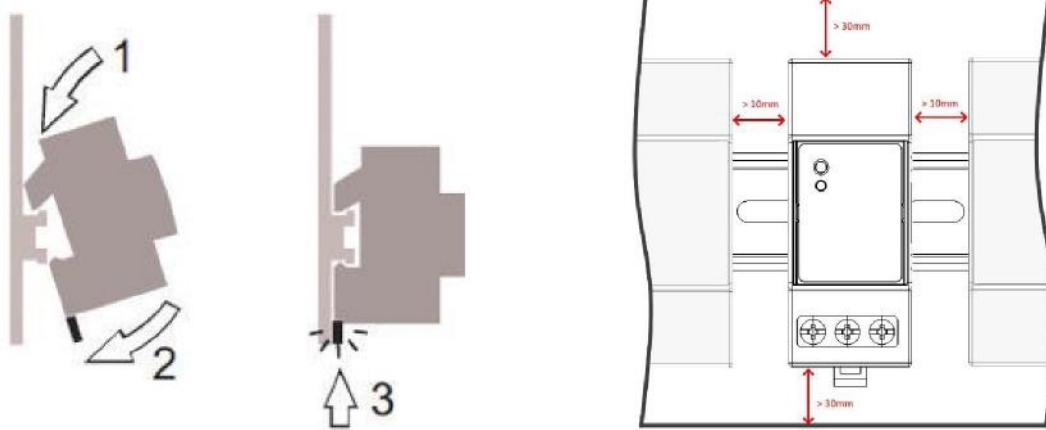

4. Wiring:

- > Use only flexible copper wires with the following cross sections for wiring the Waymeter

MAXIMUM PEAK CURRENT (A)	UP TO 16 A	FROM 16 A TO 25 A	FROM 25 A TO 32 A	FROM 32 A TO 46 A
Minimum wire cross-section (mm ²)	2.5	4	6	10
Minimum wire cross-section (AWG)	12	10	8	6

- > Use PVC-insulated wires able to withstand temperatures of at least 80 °C. Such as H05V2-K, AWM Style 1007, or equivalent.
- > Ensure that all stranded wires are inserted into the screw terminal to ensure good contact.

⚠ WARNING

Ensure that the terminals are tight to ensure good contact. The required tightening torque is 1.8Nm. Use a 1.2x6.5 slotted or PZ2 Phillips screwdriver.

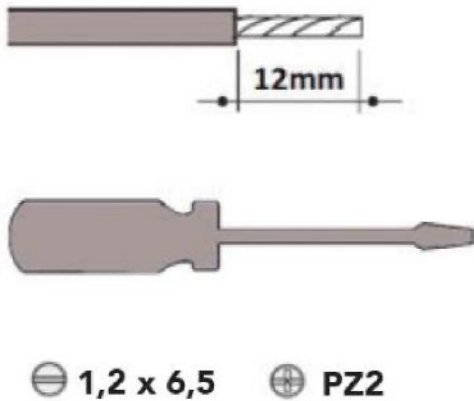

5. Connections:

STANDARD VERSION

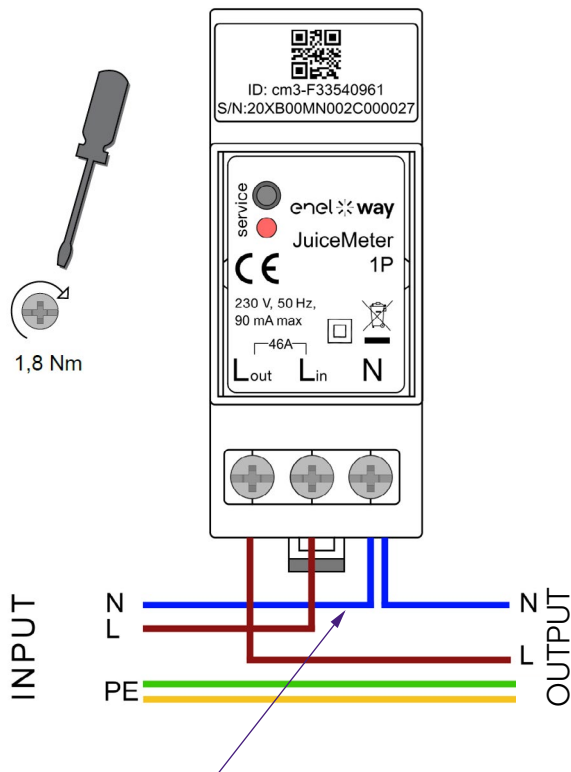

For the neutral, the installer must make a branch from the power cable.

SINGLE-PHASE measurement method:

with integrated shunt between terminals "Lin" and "Lout" for current measurement. Between terminals "Lin" and "N" (same as used for Waymeter power supply) for voltage measurement.

- > **Minimum current:** 100 mA
- > **Reference current:** 5 A
- > **Maximum current:** 46 A
- > **Nominal range:** 34 A; Contracted power up to 8 kW
- > **Maximum range (for short periods only):** 46 A. Power up to 10.6 kW.
- > **Accuracy:** class I ($\pm 1\%$) for active energy
- > **Measurement category:** CAT II according to EN 61010-2-30

⚠ WARNING

Check that there is an MCB switch in the main switchboard that is suitable for the protection/disconnection of the Waymeter (In max 40 A). If this is not the case, it must be replaced. The MCB must be marked as Waymeter disconnecting device.

IT GRID VERSION

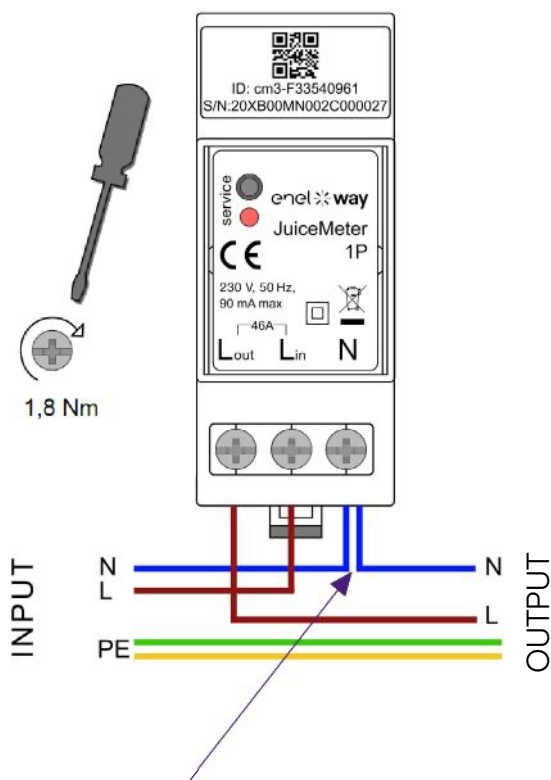

For the neutral, the installer must make a branch from the power cable.

SINGLE-PHASE measurement method: with integrated shunt between terminals "L_{in}" and "L_{out}" for current measurement. Between terminals "L_{in}" and "L_{2/N}" (same as used for Waymeter power supply) for voltage measurement.

- > **Minimum current:** 100 mA
- > **Reference current:** 5 A
- > **Nominal range:** 34A; Contracted power up to 8kW
- > **Maximum range (for short periods only):** 46 A. Power up to 10.6KW
- > **Accuracy:** class I ($\pm 1\%$) for active energy
- > **Measurement category:** CAT II according to EN 61010-2-30

⚠ WARNING

Check that there is an MCB switch in the main switchboard that is suitable for the protection/disconnection of the Waymeter (In max 40 A). If this is not the case, it must be replaced. The MCB must be marked as Waymeter disconnecting device.

POWER-UP AND COMMISSIONING

PLUG&PLAY PRODUCT

Power-up the product.

- > FIXED RED SERVICE LED: powered and operational - Active communication and data transmission to Waybox.
- > Flashing RED SERVICE LED (Fast blink): Modem Power Line fault.
- > BLINKING RED SERVICE LED (Slow blink): Measurement Unit fault.
- > SERVICE BUTTON: Reset button for the device (press for at least three seconds to restart the device without performing an on-off cycle).

2.3 Waybox connection diagrams

STANDARD VERSION

NOTE:

PLC - CHAIN2 (*) communication takes place on connections L and N.

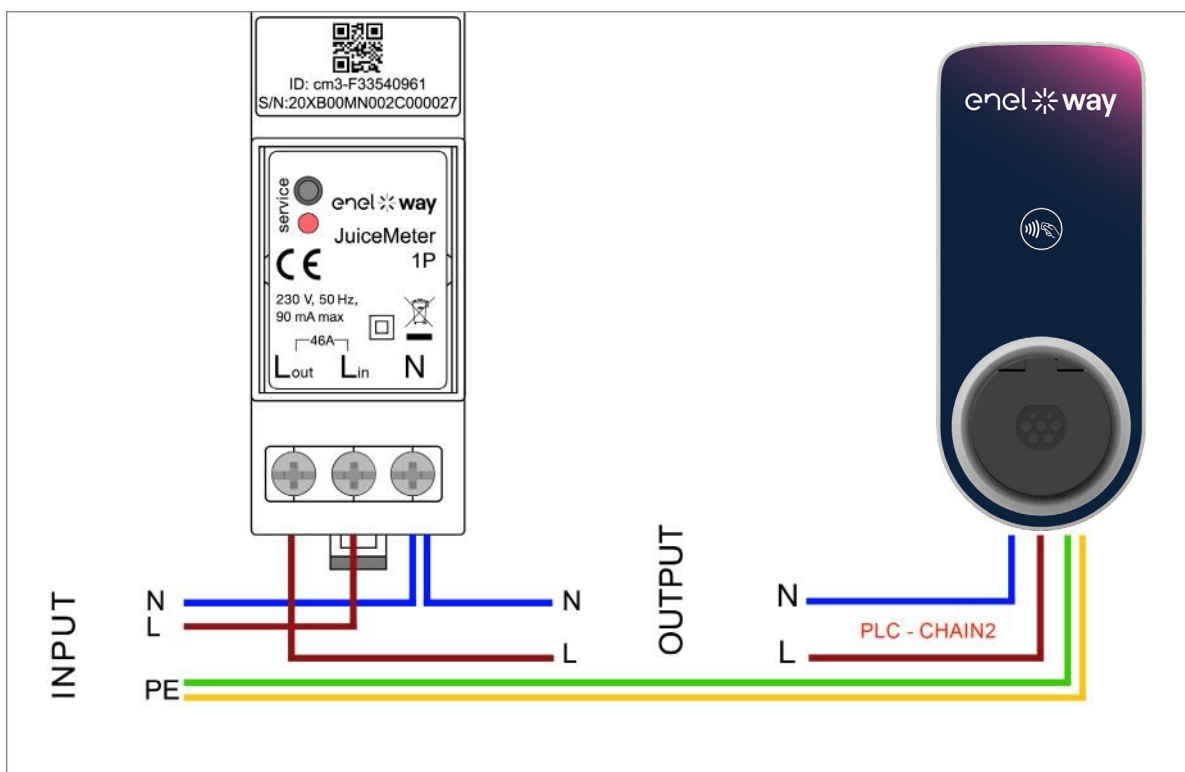

(*) The chain2 protocol is customised with more measurement data than the standard one.

IT GRID COMPATIBLE VERSION

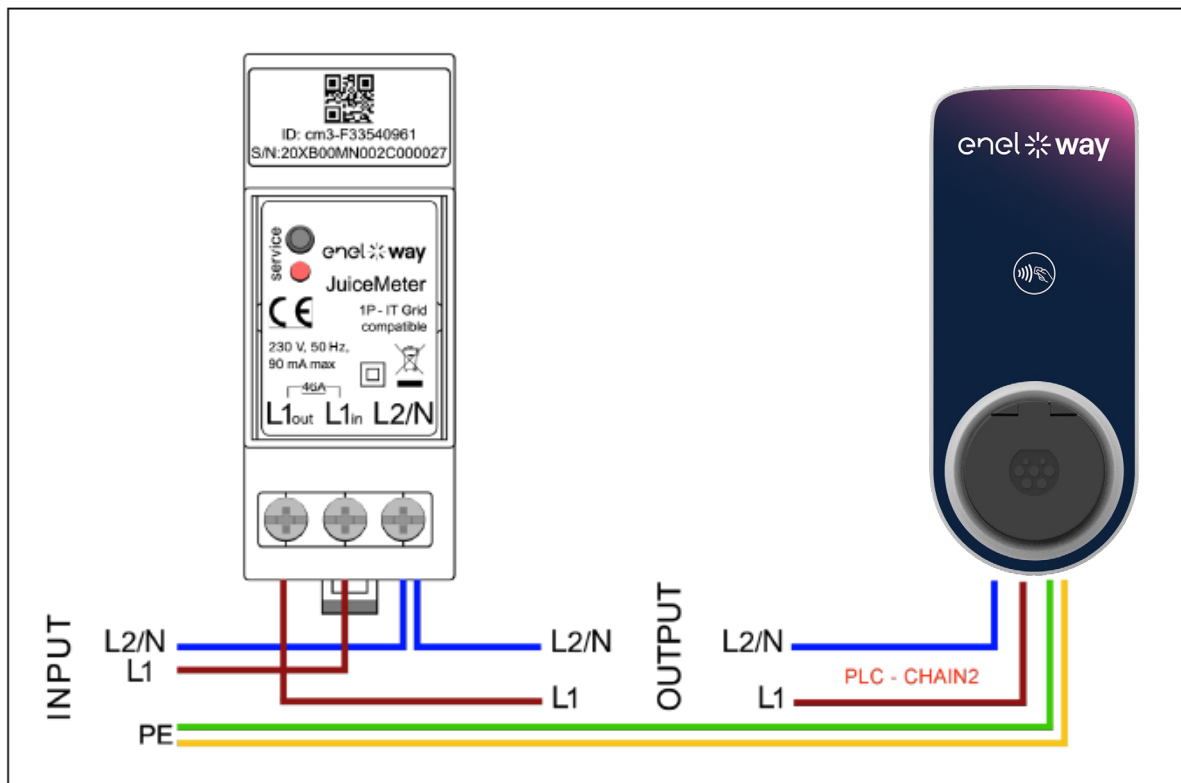

3 Three-phase Waymeter

STANDARD VERSION	IT GRID VERSION
<p>Compatible for installation in the following electrical system topologies:</p> <ul style="list-style-type: none"> > TT, TN, TN-S, TN-C, TN-C-S, IT with Neutral. 	<p>Compatible for installation in the following electrical system topologies:</p> <ul style="list-style-type: none"> > TT no Neutral, IT no Neutral.

3.1 Features

- > **Dimensions (W x H x D):** 1.4 in/36.3 mm x 3.6 in/90.5 mm x 2.4 in/62 mm (not considering DIN RAIL Clip)
- > **N° DIN Modules:** 3
- > **Weight:** 150 g
- > **IP Grade:** IP20 (when Waymeter is installed in Electrical Panel with terminals covered by panel)
- > **Case material:** PC/ABS
- > **Flame Rate:** UL94 V-0

OPERATING CONDITION

- > **For Indoor use**
- > **Operating temperature:** -4 °F to +122 °F (-20 °C to 50 °C)
- > **Storage temperature:** -22 °F to +158 °F (-30 °C to 70 °C)
- > **Relative humidity:** 5% ÷ 95% not condensed
- > **Altitude:** <= 4000 m
- > **Overvoltage class:** II
- > **Pollution degree:** 2
- > **Insulation class:** II 

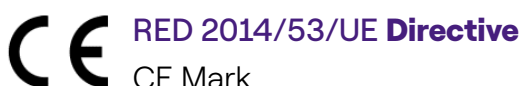

Product distributed by Enel X Way, Via Ostiense 131L, 00154, Rome, Italy

POWER

- > **Connection:**
- > Standard Version: Feed the product with terminals "T" and "N", the same that are used for the voltage measurement.
- > IT GRID Version: Feed the product with terminals "T" and "R", the same that are used for the voltage measurement.

- > **Nominal voltage:** 230 Vac
- > **Operating voltage range:** -20%/+15% of the nominal voltage
- > **Frequency:** 50 Hz
- > **Power consumption:** 120 mA max
- > **Protection:** Internal Fuse on PCB (F1: T1A 300V) not replaceable. If the fuse breaks, the device switches off and the dynamic modulation of the load fails.

CONNECTIONS

- > **Terminals:** 8 way Screw Terminals.
- > **Wiring size (min ÷ max):** 0.5 ÷ 2.5 mm²/ 22AWG ÷ 14AWG

WI-FI / BLUETOOTH COMMUNICATION (FEATURE CURRENTLY NOT AVAILABLE)

- > **Function:** Optional commissioning with APP
- > **Antenna:** Built in
- > **Frequency:** 2.4 GHz
- > **Standard:** 802.11 b/g/n

PLC NARROW BAND COMMUNICATION (CHAIN 2)

- > **Modem:** C-Band, B-PSK Modulation
- > **Application:** DLMS/COSEM IEC (IEC 62056-5-3)
- > **Data Model:** COSEM Data Model (IEC 62056-6-1, IEC 62056-6-2)
- > **Coupling:**
 - > Standard version: PLC communication differential mode coupled on terminals "T" and "N".
 - > IT GRID Version: PLC communication differential mode coupled on terminals "T" and "R".

USER INTERFACE:

- > **LED Service:** Power on Service LED (red)
- > **Button:** For initial configuration and Reset.

STANDARDS

- > **Art. 3.1a Safety:** EN 61010-1:2010/A1: 2010, EN EN 61010-2-30:2010
- > **Art. 3.1b EMC:** EN 55032:2015/A11:2010, EN 55035:2017/A11:2010, EN 61000-3-2:2019, EN 61000-3-3:2013/A1:2019, ETSI EN 301 489-1 V2.2.3 (2019), ETSI EN 301 489-17 V3.2.2
- > **Art. 3.2 Radio:** ETSI EN 300 328
- > **Health:** EN 62311

3.2 Installation

Install the Waymeter down of the distributor meter and the main switch to allow the measurement of overall consumption (see diagram below).

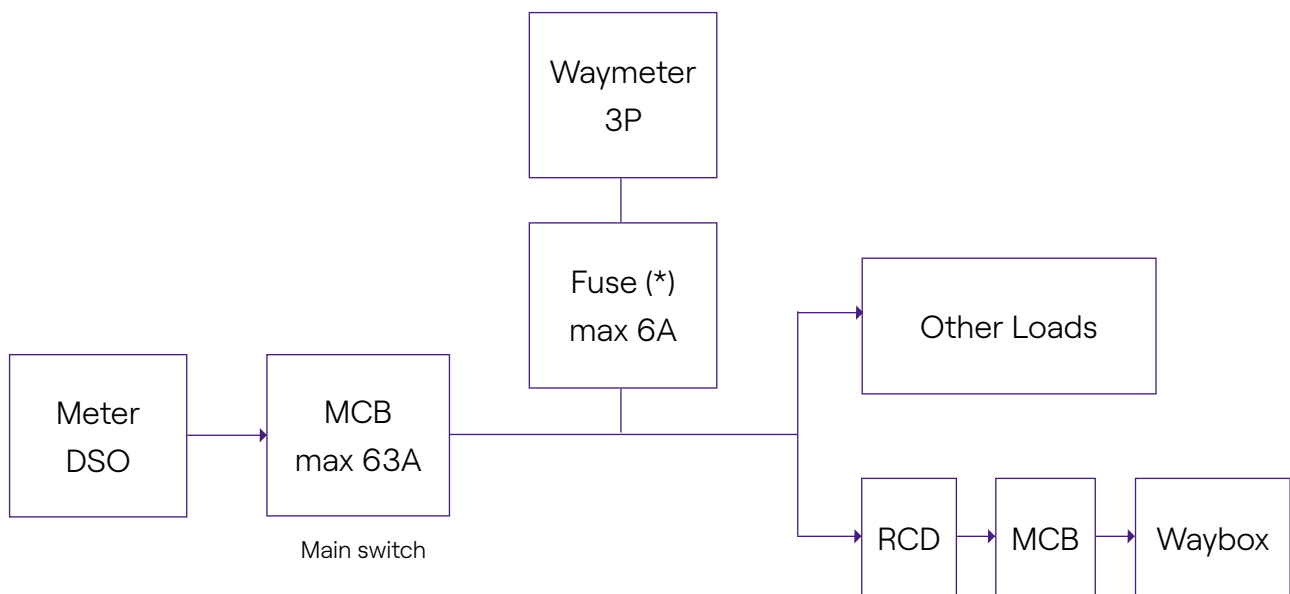

NOTE: For protection of the electrical system circuit, it is recommended to install:

- For Waymeter Standard Version one circuit breaker 3P +N, with a fuse for each phase;
- For Waymeter IT GRID Version one circuit breaker 3P, with a fuse for each phase.

This Circuit Breaker must be marked as Waymeter disconnecting device.

1. Please, read the **safety warnings** provided with the Waymeter before performing any operation on the product. **Safety warnings** is included in the package.
2. Install the product in an electrical panel accessible only by qualified personnel
3. Din rail mount.
 - > The product must be installed in vertical position on a 35mm DIN rail, with the screw terminal facing downwards.
 - > Leave at least 30mm of space above and below the Waymeter, and at least 10mm of space to the right and left of the product from adjacent DIN modules, to ensure proper heat dissipation. (evaluate whether to insert the drawing on the right).
 - > It is not recommended to install the product near heat sources. If necessary, keep an adequate distance between the Waymeter and these heat sources.

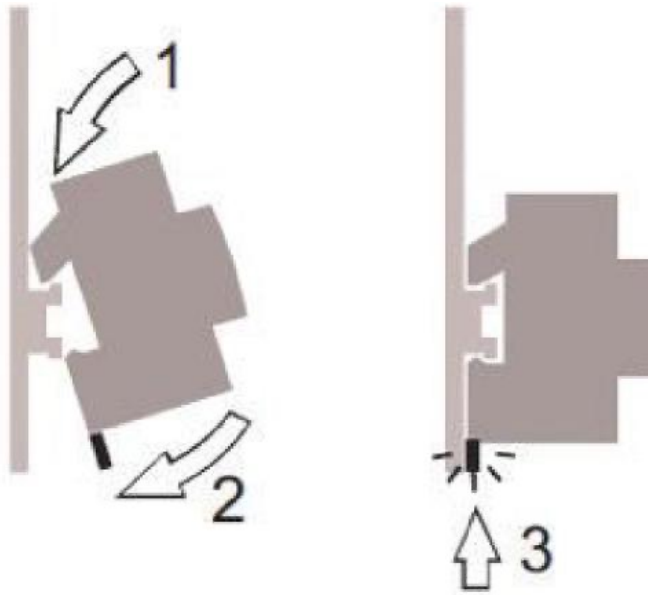

4. Wiring size (min÷max): 0.5÷2.5mm²/22AWG÷14AWG

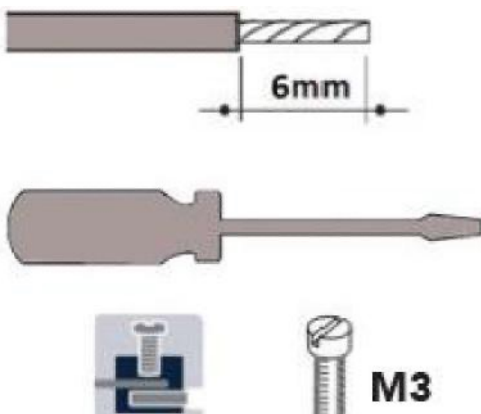

5. Connections.

STANDARD VERSION

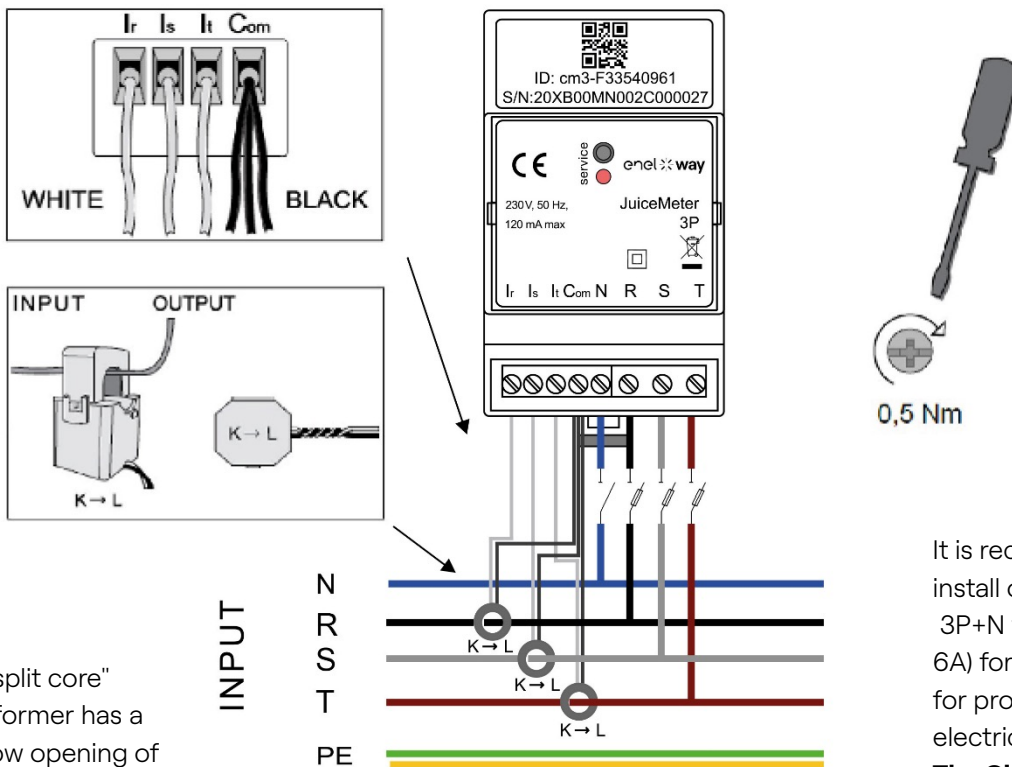

The "split core" transformer has a window opening of 10mm/0.39"

It is recommended to install one circuit breaker 3P+N with a fuse (max 6A) for each phase, for protection of the electrical circuit.

The Circuit Breaker must be marked as Waymeter disconnecting device.

THREE-PHASE measurement:

with "split core" amperometric transformers for current measurement, to be connected with the black wires in common on the "Com" terminal and the white wires on the respective "Ir", "Is" and "It" terminals as per wiring diagram.

The voltage is measured between terminals "R" and "N", "S" and "N", "T" and "N". "T" and "N" are also used for the single-phase power supply of the device

"Split core" transformers:

To be applied on the cables of the 3 phases, as per the wiring diagram beside. Pay attention to the "K → L" marking on the transformers themselves.

Pay attention to the terminals for connecting the current transformers which refer to the primary circuit.

The amperometric transformers must be wired and used inside the electrical panel that ensures their isolation from the user.

Waymeter can only be used with the current transformers supplied. Replacement with

other types of products is not permitted. Any replacements or repairs must be done by the manufacturer.

Rating for Each Phase:

- > **Minimum Current:** 100 mA.
- > **Reference current:** 5 A.
- > **Max Current:** 60 A.
- > **Max Power:** 13.8 kW.
- > **Accuracy:** class I ($\pm 1\%$) for active energy.
- > **Measurement Category:** CAT II according to EN 61010-2-030.

Note: if connected in single phase system, connect the single phase line on screw terminals T and N of Waymeter. See Waybox connection diagrams.

IT GRID VERSION

Three-phase IT system without Neutral, with phase-to-phase voltage 230V.

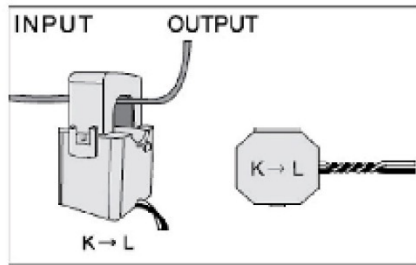
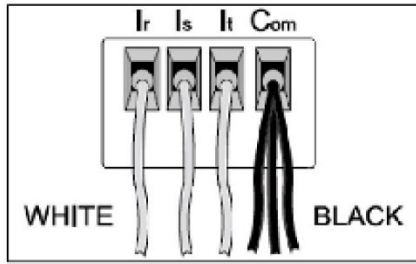

The "split core" transformer has a window opening of 10mm/0.39"

INPUT

R
S
T
PE

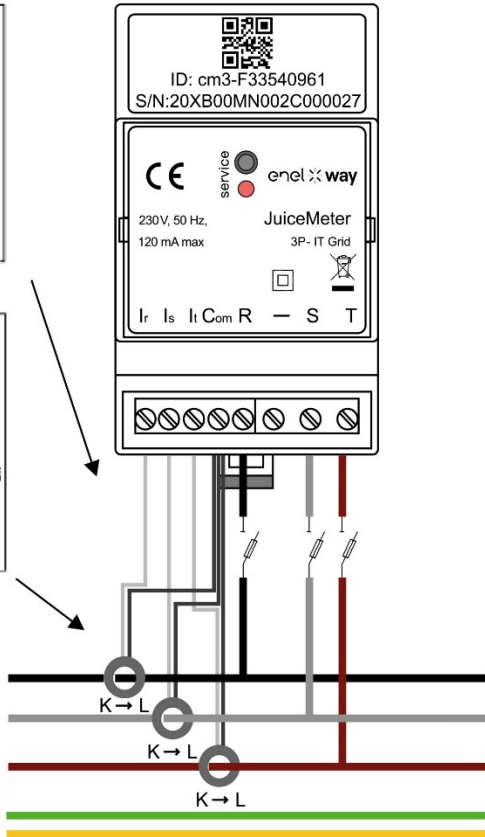

It is recommended to install one circuit breaker 3P with a fuse (max 6A) for each phase, for protection of the electrical circuit.

The Circuit Breaker must be marked as Waymeter disconnecting device.

THREE PHASE measurement:

with "split core" amperometric transformers for current measurement, to be connected with the black wires in common on the "Com" terminal and the white wires on the respective "Ir", "Is" and "It" terminals as per wiring diagram.

The voltage is measured between terminals "R" ed "S", "R" ed "T".

T" and "R" are also used for the single-phase power supply of the device

Amperometric transformers:

To be applied on the cables of the 3 phases, as per the wiring diagram beside. Pay attention to the "K → L" marking on the transformers themselves.

Pay attention to the terminals for connecting the current transformers which refer to the primary circuit.

The amperometric transformers must be wired and used inside the electrical panel that ensures their isolation from the user.

Waymeter can only be used with the current transformers supplied. Replacement with other types of products is not permitted. Any replacements or repairs must be done by the manufacturer.

Rating for Each Phase:

- > **Minimum Current:** 100 mA.
- > **Reference current:** 5 A.
- > **Max Current:** 60 A.
- > **Max Power:** 13.8 kW.
- > **Accuracy:** class I ($\pm 1\%$) for active energy.
- > **Measurement Category:** CAT II according to EN 61010-2-030.

NOTE: if connected in single phase system, Connect the single phase line on screw terminals T and R of Waymeter. See Waybox connection diagrams.

COMMISSIONING

PLUG&PLAY

Feed the product

- > LED SERVICE STEADY RED: Powered and operative – Active communication and data transmission to Waybox
- > LED SERVICE FAST BLINK RED: Fault on Power Line Modem.
- > LED SERVICE SLOW BLINK RED: Fault on Measure Unit.

Service button: Device Reset button (Keep push for at least 3 seconds). It is used to restart the device without doing an on-off cycle.

3.3 Waybox connection diagrams

STANDARD VERSION

NOTE: the communication PLC – CHAIN2 (*) is on connections T- L1 and N.

Way METER THREE PHASES + Waybox 1P (Three phases System)

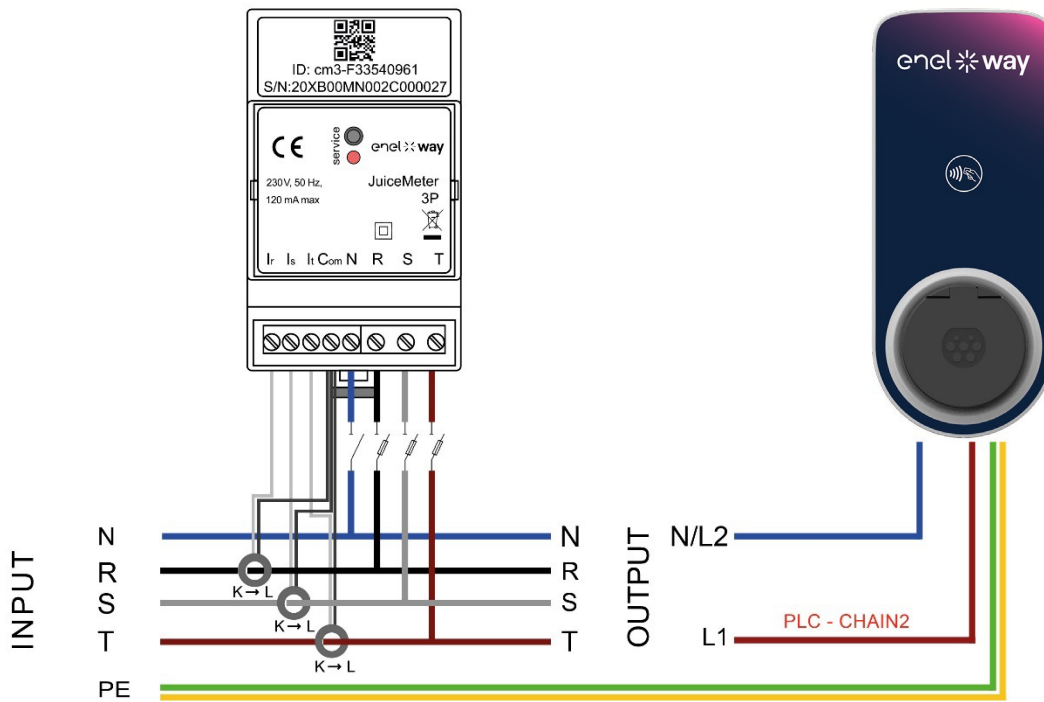

Way METER THREE PHASES + Waybox 3P (Three phases System)

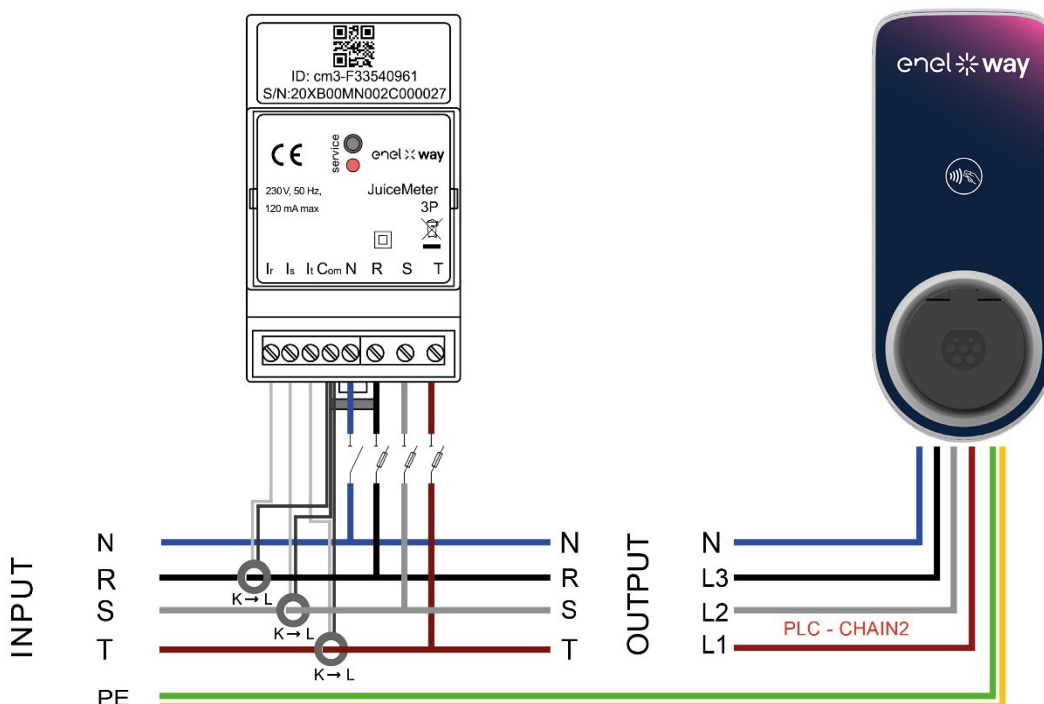

Way METER THREE PHASES + Waybox 1P (One phase System)

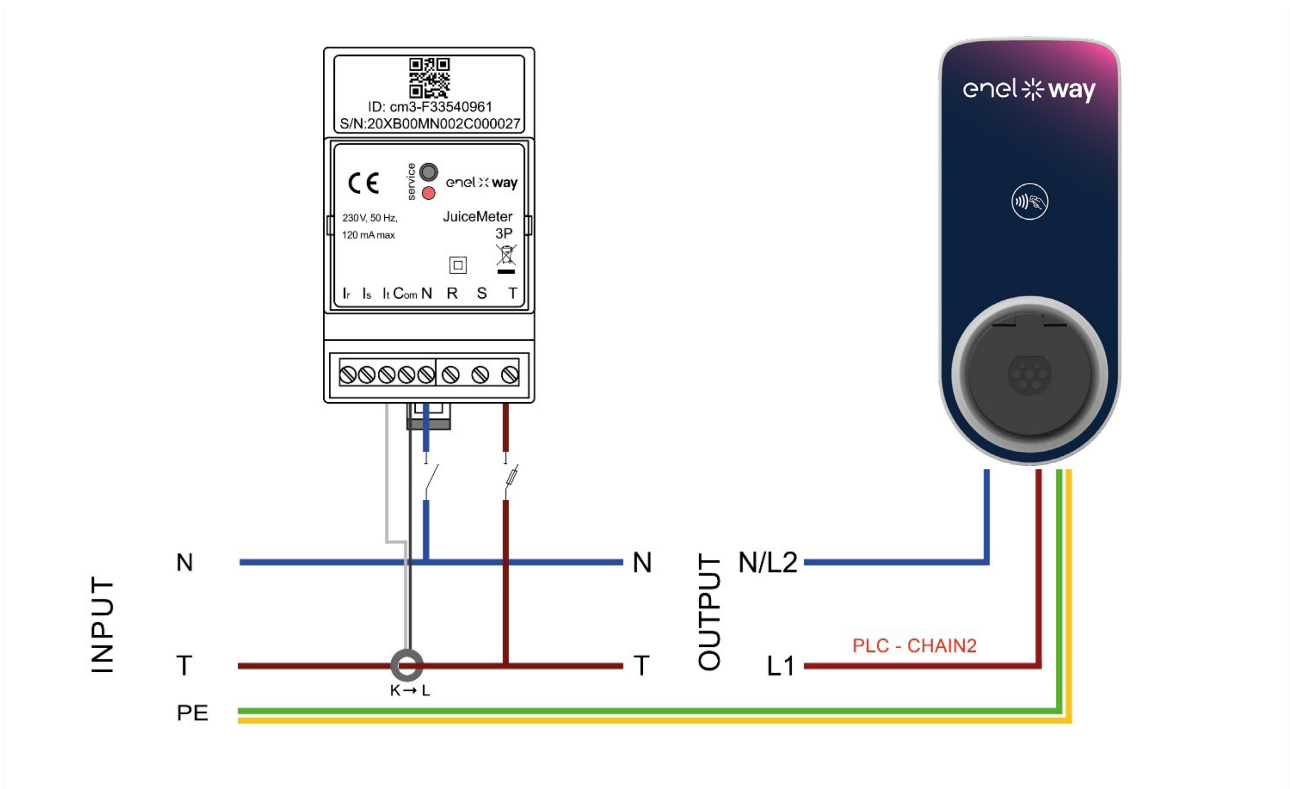

(*)the chain2 protocol is customized with more data about measures than the standard one.

IT GRID VERSION

NOTE: PLC – CHAIN2 communication (*) takes place on connections T- L1 and R.

Way METER THREE PHASES IT GRID + Waybox 1P (Three phases System)

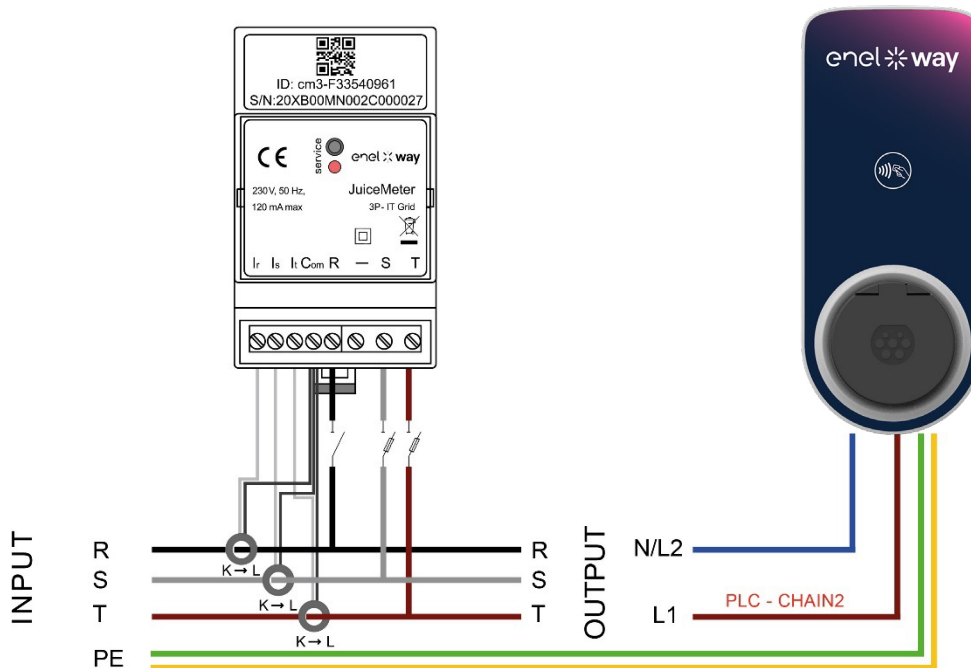

Way METER THREE PHASES IT GRID + Waybox 1P (One Phase System)

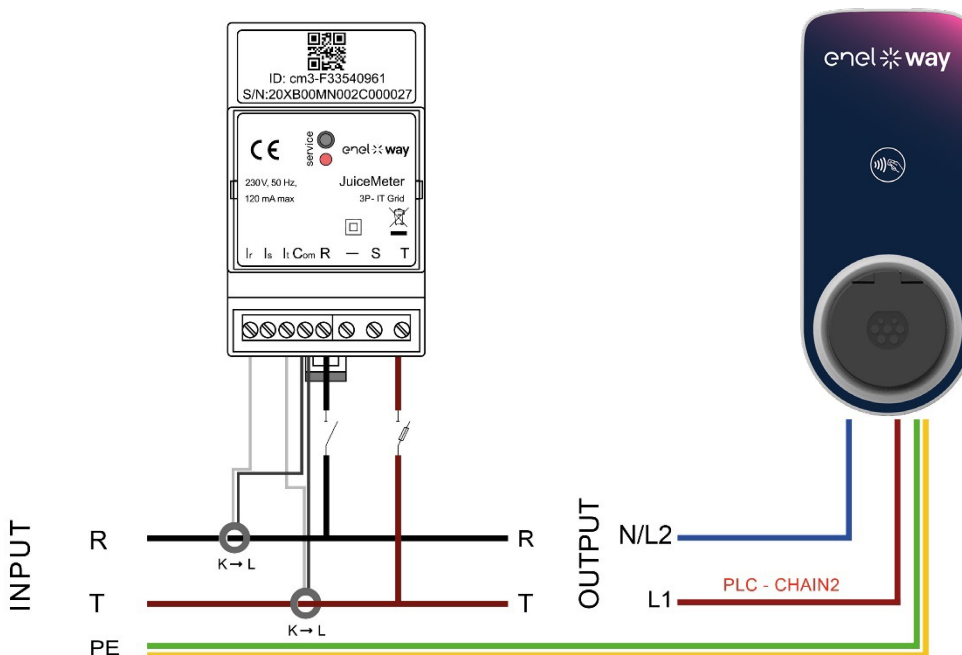

(*) the chain2 protocol is customized with more data about measures than the standard one

C: JB4Installer app manual

1 Purpose of the Manual

This manual outlines the steps to configure and/or update the firmware using the JB4Installers app for Waybox Pro and Waybox Plus.

2 Pre-requisites

- > Waybox Pro or Waybox Plus.
- > A smartphone with Android OS.
- > Enel Authorization - Contact your Enel X Way contact person to request authorization to use the app. A link will be sent to the email address provided to activate the account. After registration, another email will be sent to activate the account and to download and install the JB4Installers APP.

3 Login

1. Close all apps on your smartphone.
2. From the smartphone launch the **JB4Installers** app.

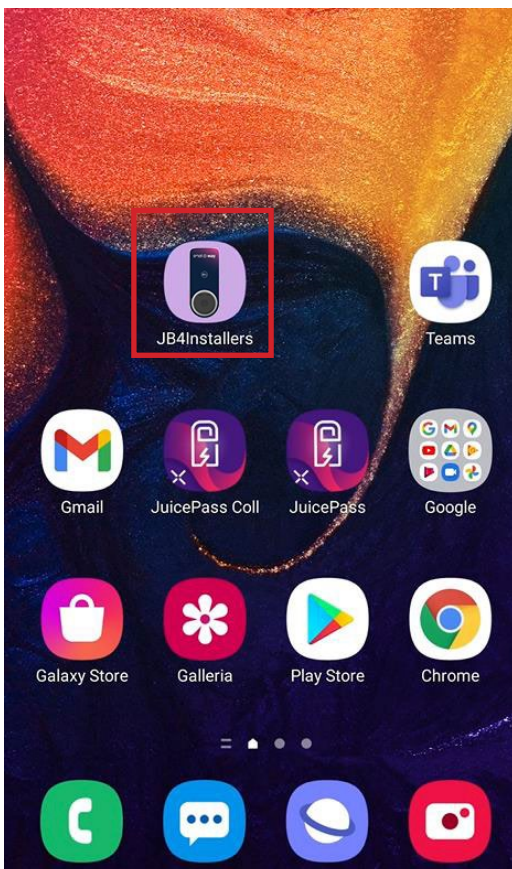

3. Insert the credentials (registration username or email, and password) to access the profile and press **Login**.

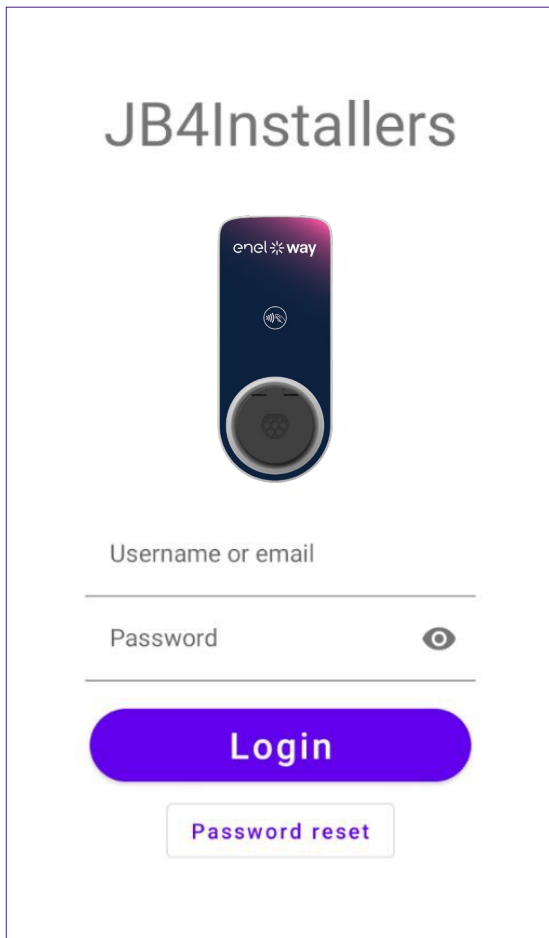

JB4Installers

enelway

Username or email

Password

Login

Password reset

4 New firmware download

NOTE:

To download new available firmware on the app, it's necessary to have internet connection on your smartphone.

After logging in, a pop-up will appear if a new firmware version is available. Press **DOWNLOAD!** and wait for the pop-up to confirm the completion of the download, then press **CLOSE**.

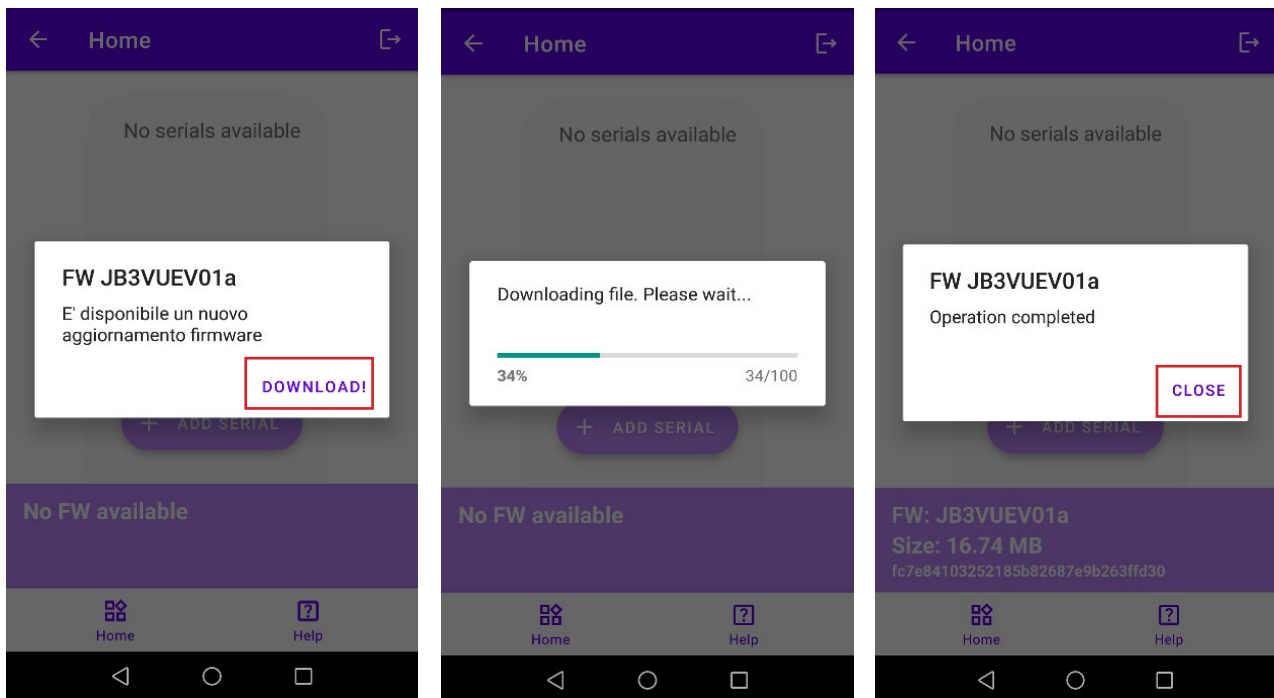

5 Loading the Waybox serial on the app

NOTE:

The following steps require that you have an active Internet connection on your smartphone.

1. Select the **+ ADD SERIAL** button, enter the serial number or scan the QR code by pressing **SCAN** and use the camera to scan the Waybox QR code.
2. Click **+ ADD** to add the serial number of the scanned Waybox to complete the operation.

NOTE:

The first time you use the APP, you must grant access to the camera: press **ALLOW**.

3. After the procedure is completed, a new item with the serial number of the Waybox will appear on the top of the screen;

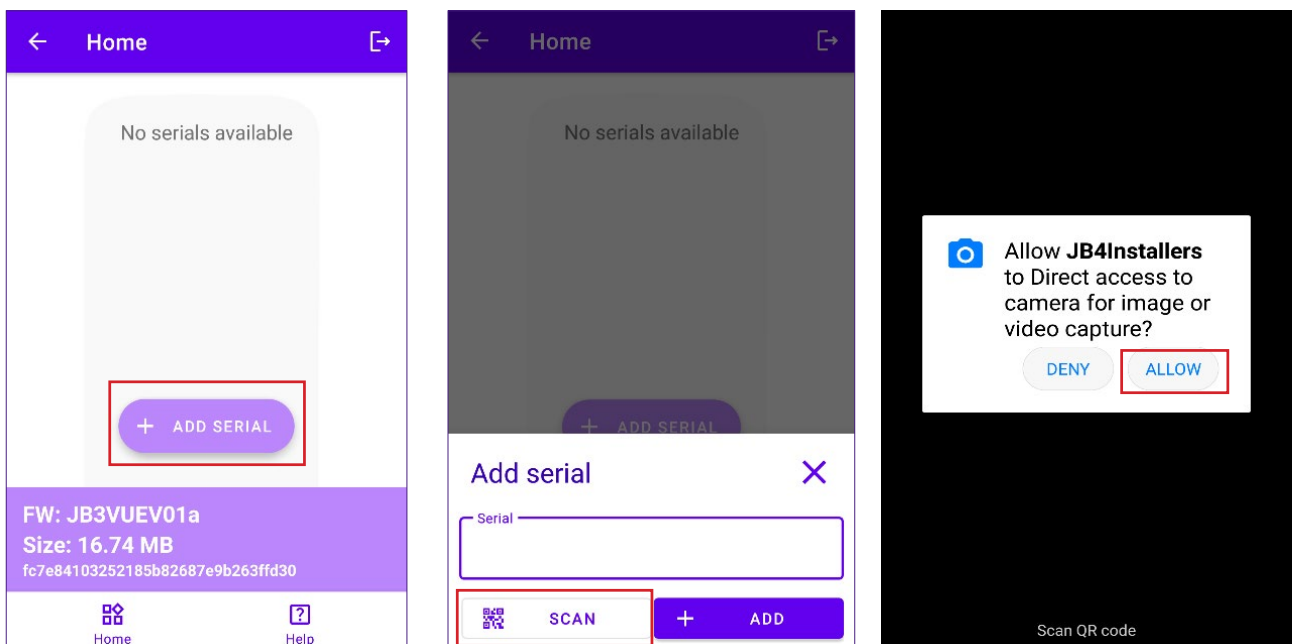

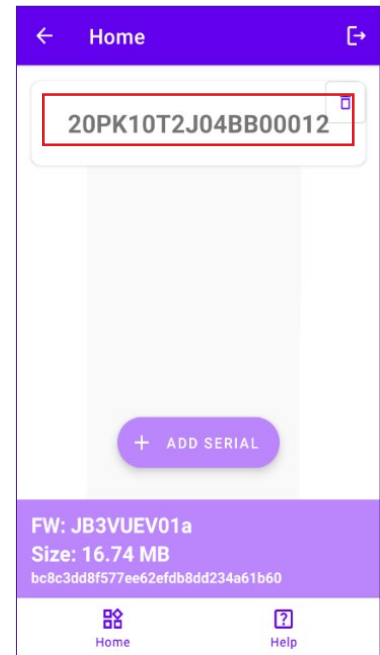
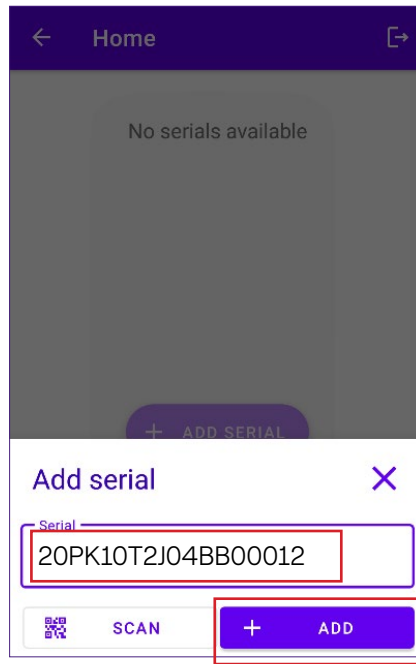
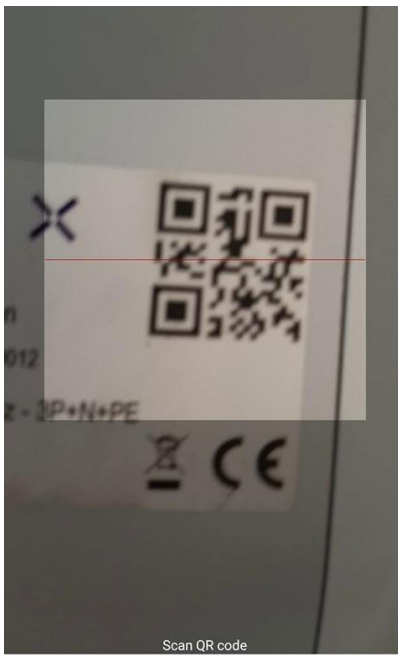

6 Connecting the Waybox to the App

NOTE:

The following steps do not require an active Internet connection on your smartphone.

1. If Wi-Fi is turned on on your smartphone, turn it off
2. Click on the item with the S/N of the Waybox.

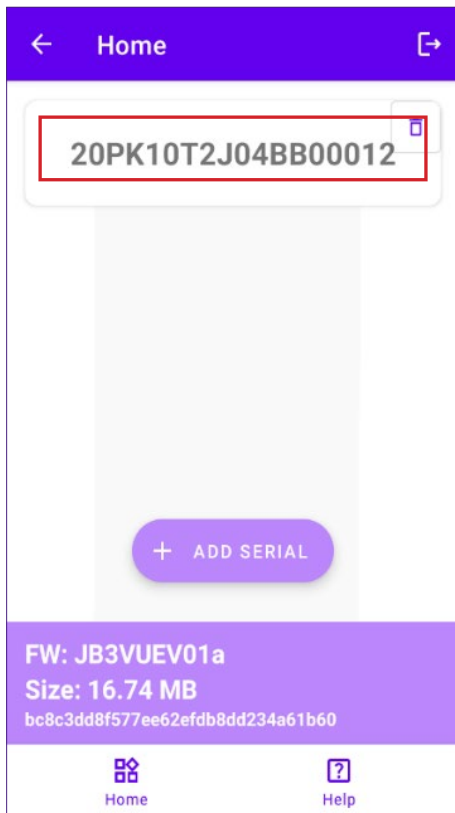

3. Power on the Waybox and wait around 30 seconds, so that the Waybox Wi-Fi hotspot is activated (the hotspot activates after the emission two acoustic signals). The hotspot remains active for 1 minute before activating on the Waybox.
4. Click on the button **ENABLE** on the app.

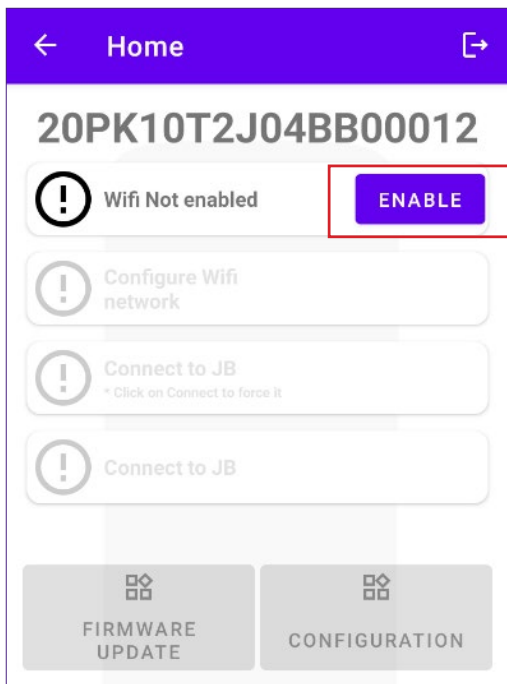

5. Enable the Wi-Fi and connect to the Waybox Wi-Fi (the name of the Wi-Fi is Waybox-XXX, whereas XXX are the last three digits from the Serial Number).

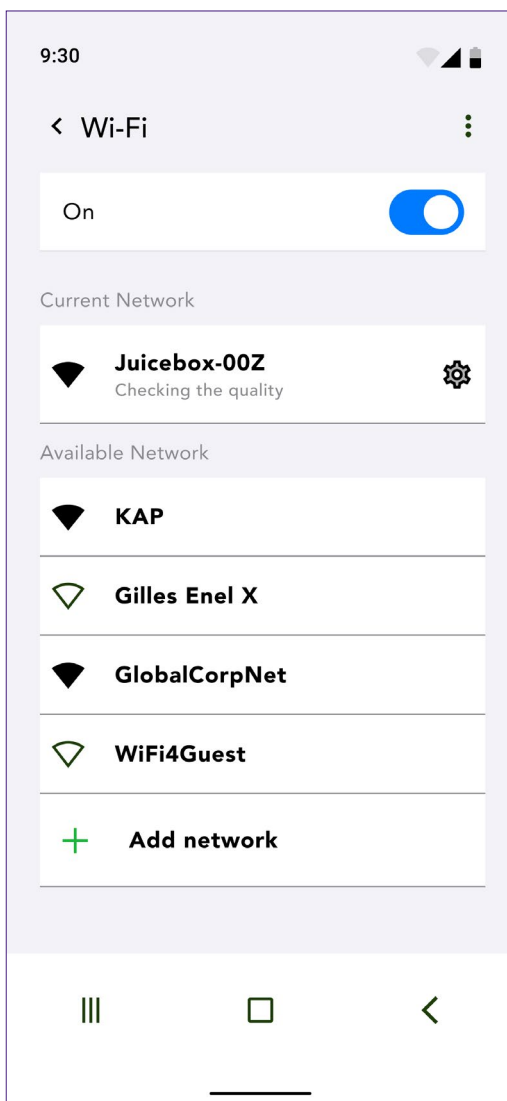

6. Wait for the Waybox Wi-Fi connection to be established. The process will be completed after all the symbols appear. 

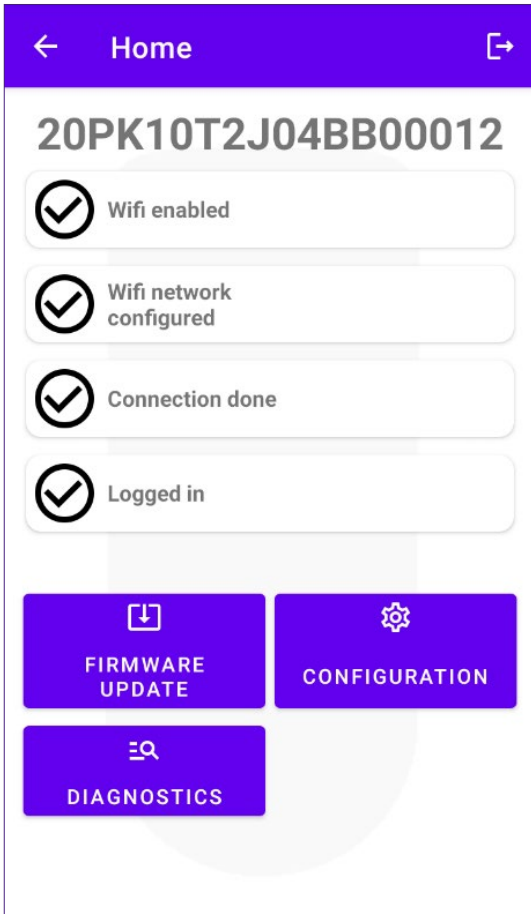

7 Firmware Update

NOTE:

The following steps do not require an active Internet connection on your smartphone.

To update the Waybox firmware:

1. Click the **FIRMWARE UPDATE** button;

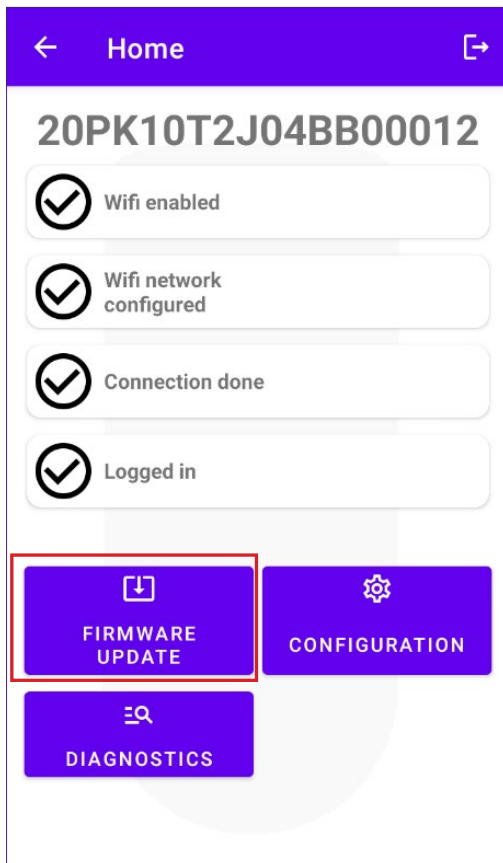

2. If a new firmware version is available, update the firmware by clicking on the **UPDATE** button;

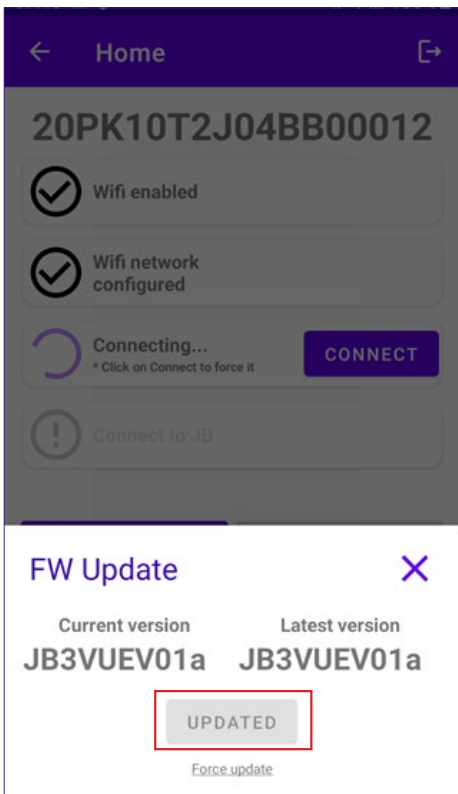

NOTE:

if the firmware is already updated it is possible to Force Update clicking on the relevant button shown in the above picture.

3. Wait for the update completion.

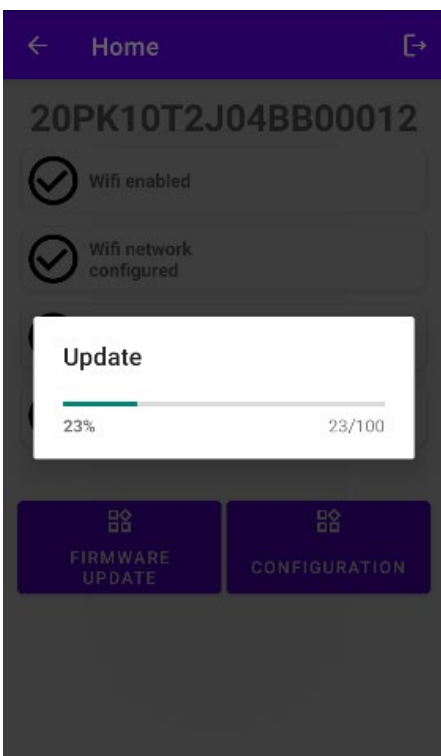

4. Press **CLOSE** to exit from the firmware update stage.

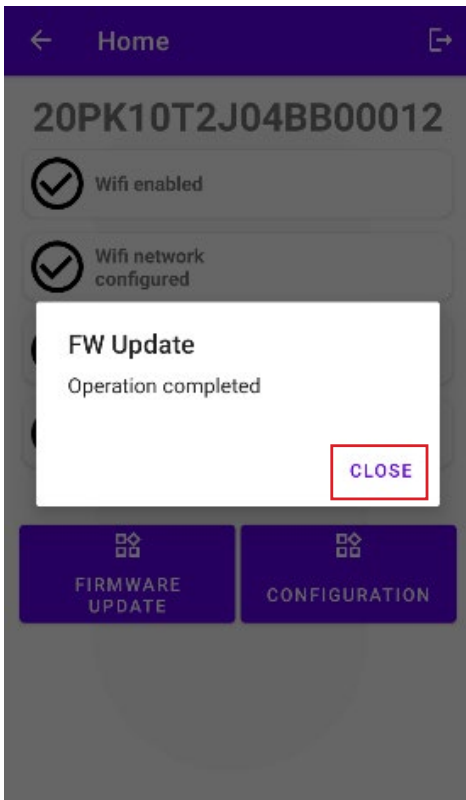

8 Waybox Connectivity Check for Cellular Versions

1. Click the **DIAGNOSTICS** button;

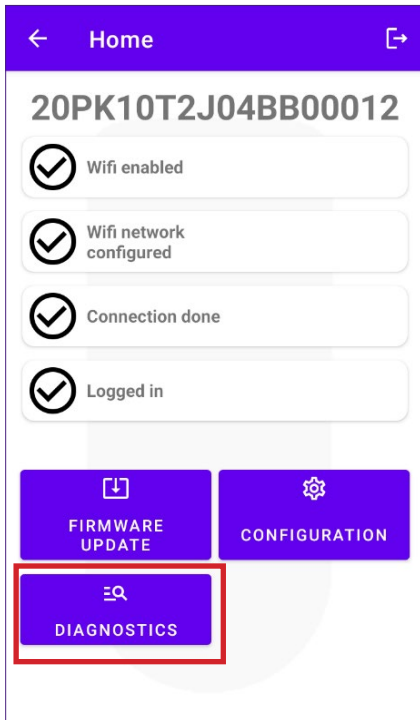

2. Select the **MODEM** button;
3. Click on the **START MONITORING** button;
4. Click **OK**;

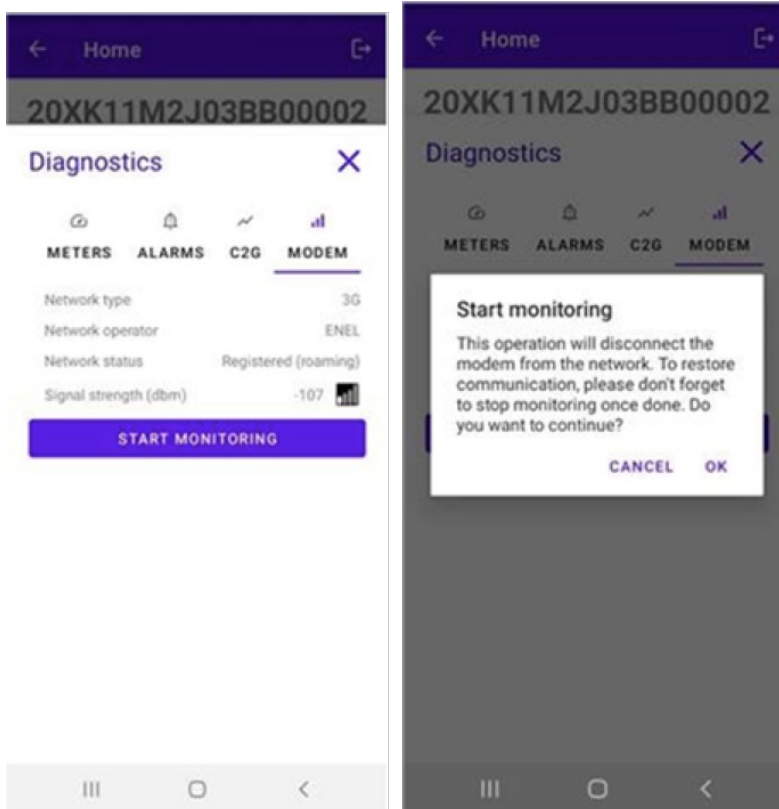
**NOTE:**

The signal measured in dBm can be displayed in the **Signal Strength** field. The minimum signal for which the Waybox has sufficient connection to connect online is **-85 dBm** (an example with poor connectivity is shown in the figure (indeed, $-109 < -85$)).

5. To stop the measurement, click **STOP MONITORING** and then click **OK**.

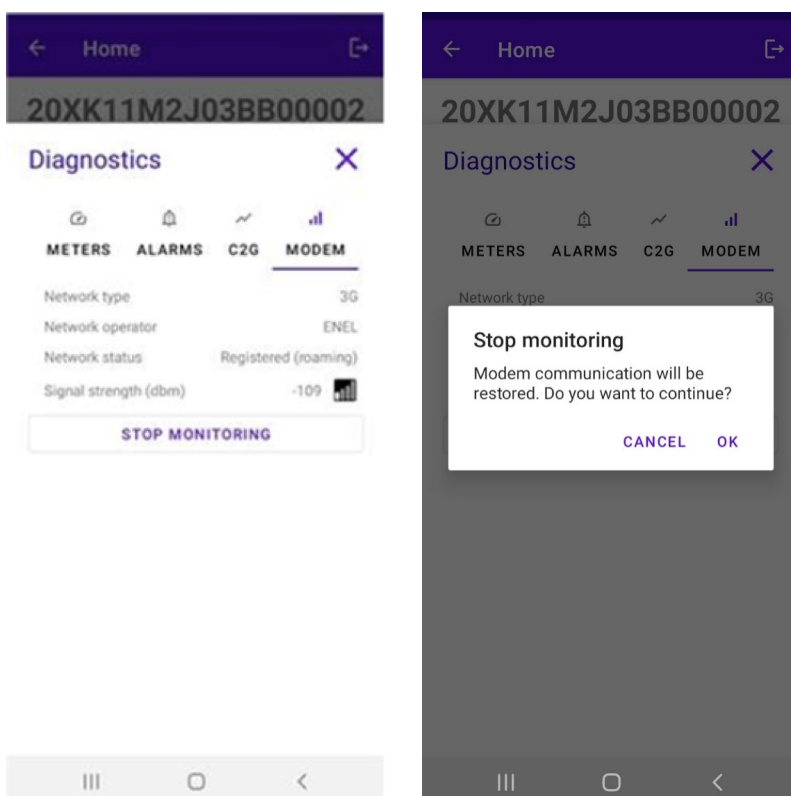

9 Waybox Configuration

NOTE:

The following steps do not require an active Internet connection on your smartphone.

1. Select **CONFIGURATION** to enter in the Way Box Configuration Menu;

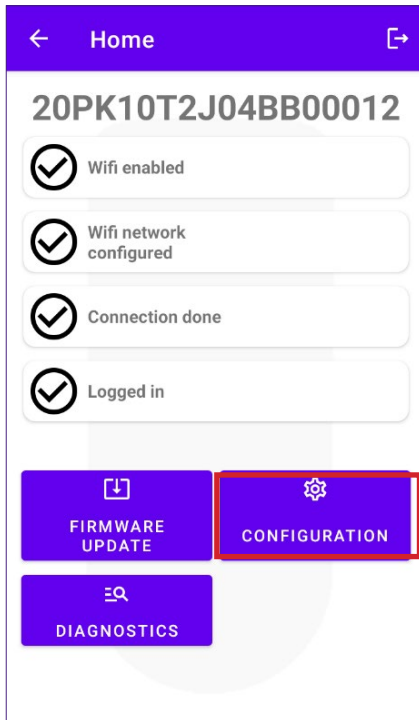

9.1 Configuration of the "Supply System" Parameter

This configuration must be made in case of the installation of a three-phase Waybox on a single-phase or bi-phase supply system.

1. Select the **ADVANCED** tab.
2. Select the **Supply System** tab.
3. Set the value to:
 - 3.1 "Monophase" in case of Single-phase supply system.
 - 3.2 "Biphase" in case of a Bi-phase supply system.
4. After performing the configuration click the **SAVE** button.
5. Click the **REBOOT** button.

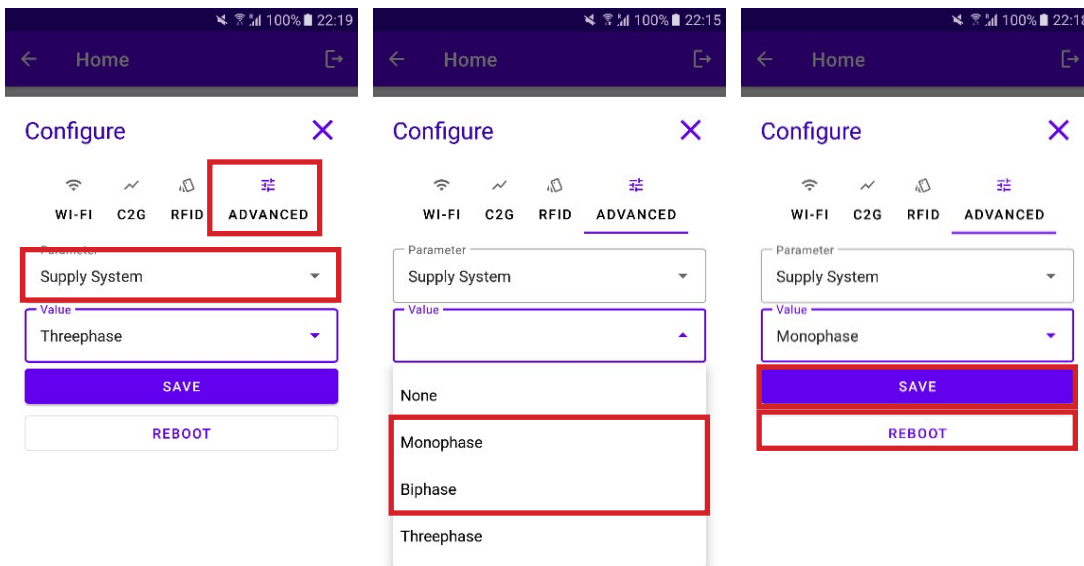

9.2 Wi-Fi Configuration

To configure a Waymeter select the **Wi-Fi** tab and fill in the required sections.

1. Select the **Wi-Fi** tab.
2. Select the Wi-Fi Scan button.
3. Select the Wi-Fi network.
4. Enter the password.
5. Click the **SAVE** button.

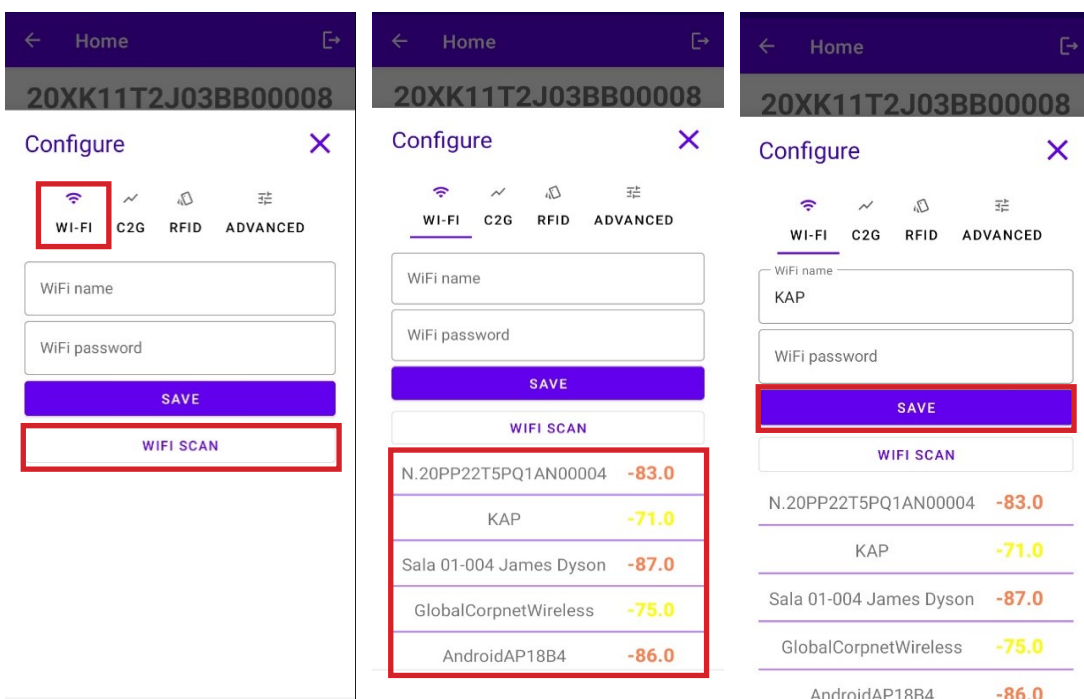

9.3 Waymeter Configuration (for Waybox Pro)

To configure a Waymeter select the **C2G** tab and fill in the required sections (Enable, DU, KEY, CONTRACTUAL POWER):

1. Select the **C2G** tab.
2. Select the **Enable** tab and then set the value to **True**.
3. Insert the Waymeter's **DU** and **KEY** parameters that are printed in the label inside the Waymeter's packaging.

NOTE:

As an alternative to the DU and KEY parameters, it is possible to enter only the **Meter ID** parameter directly on the Waymeter.

4. Insert the **CONTRACTUAL POWER** value expressed in W (Watt) (e.g. to configure a 3.3kW Contractual Power the value to be inserted is 3300).
5. After performing the configuration click the **SAVE** button.
6. Click the **REBOOT** button.

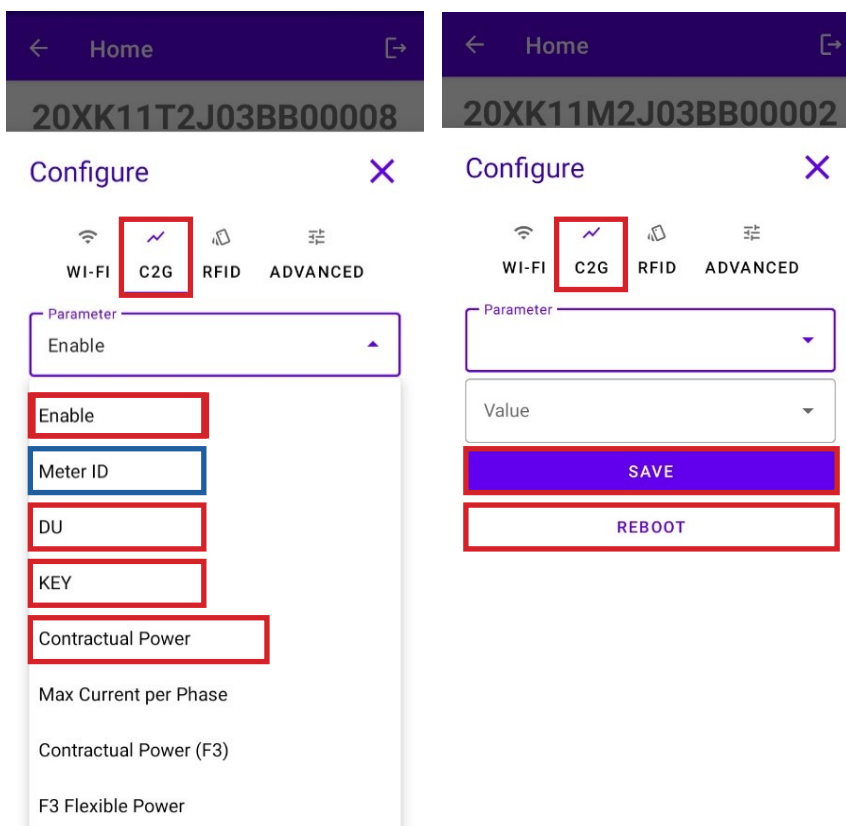

- Check in the diagnostics section that the communication between the Waybox and the Waymeter is working properly (**C2Engine** and **C2G Powerline** should be green with the word OK).

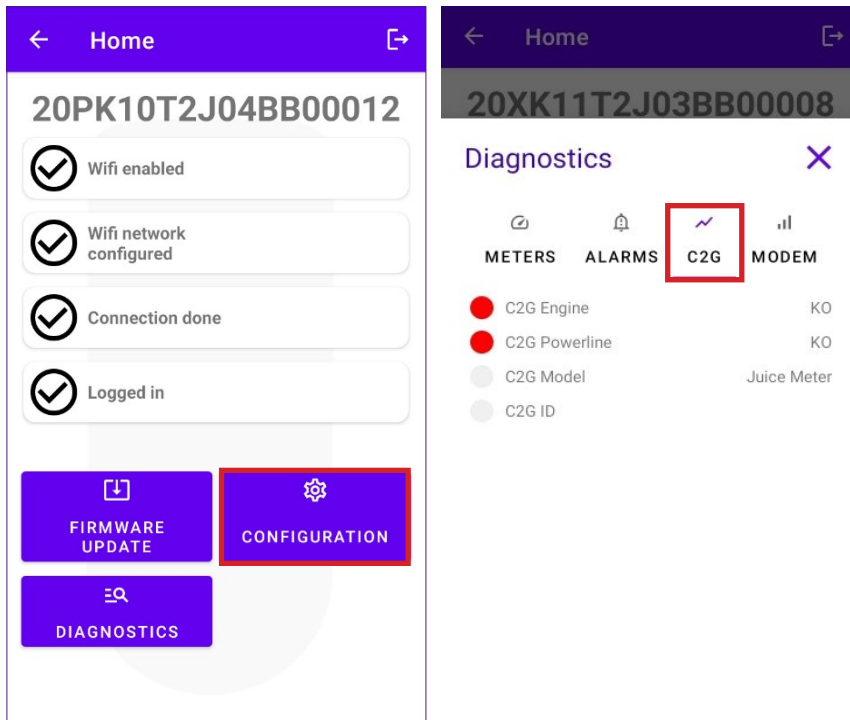

9.4 Configuration of the Waybox in Standalone Mode

NOTE:

Follow this procedure in case you need to configure a station that has been already commissioned in absence of cellular connectivity.

Configuration of the Waybox in Standalone Mode:

- Select the **ADVANCED** tab.
- Select the **OPERATING MODE** tab.
- Set the value to **Standalone**.
- After performing the configuration click the **SAVE** button.
- Click the **REBOOT** button.

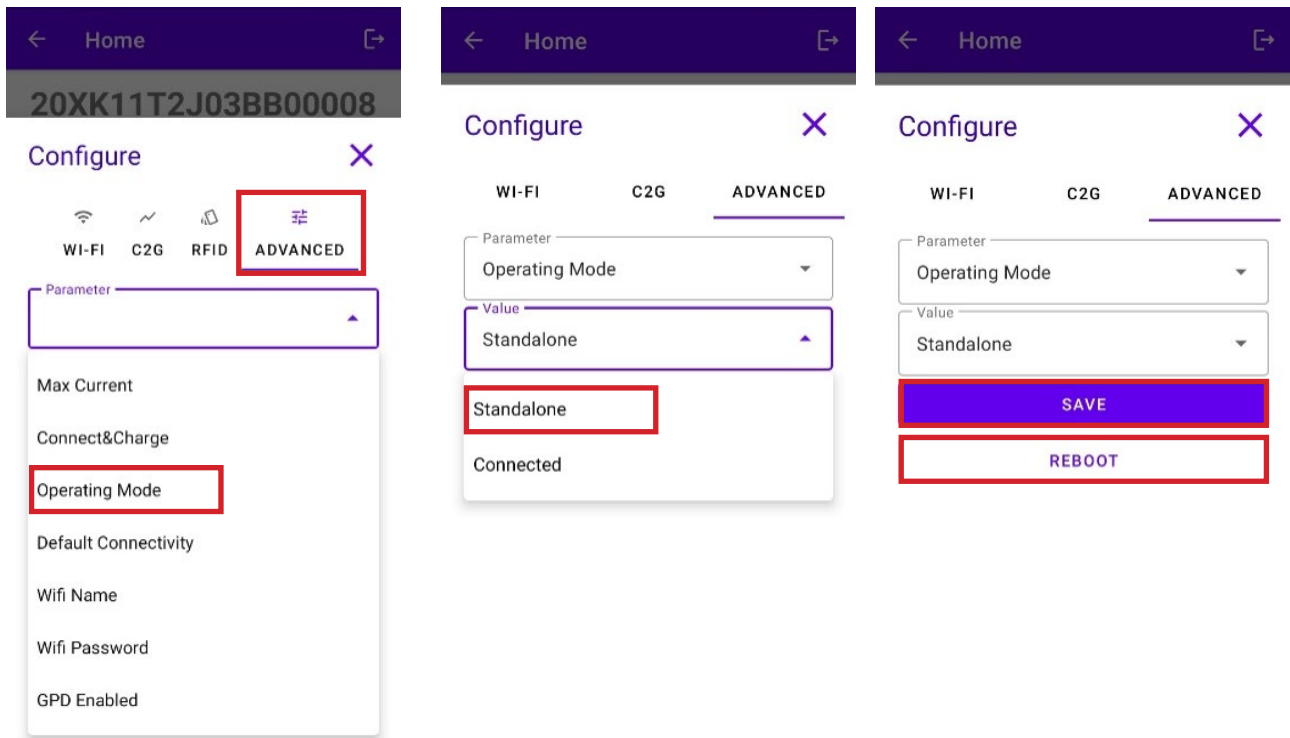

9.5 Configuration of the Waybox in Absence of Cellular Connectivity

NOTE:

The following steps do not require an active Internet connection on your smartphone.

NOTE:

You can configure the following parameters only if the station has not been commissioned yet. If the station has already been commissioned in the back-end, the following configuration will have no effect unless the Standalone mode of operation is configured first (see the [section 9.4](#) of this manual).

First of all, make sure that the firmware version of the Waybox is up to date (follow the procedure in section 7 of this manual).

9.5.1 CONNECT&CHARGE MODE CONFIGURATION

Configuration of the Waybox in Connect&Charge Mode:

1. Select the **ADVANCED** tab.
2. Select the **Connect&Charge** tab.
3. Set the value to **On**.
4. After performing the configuration click the **SAVE** button.
5. Click the **REBOOT** button.

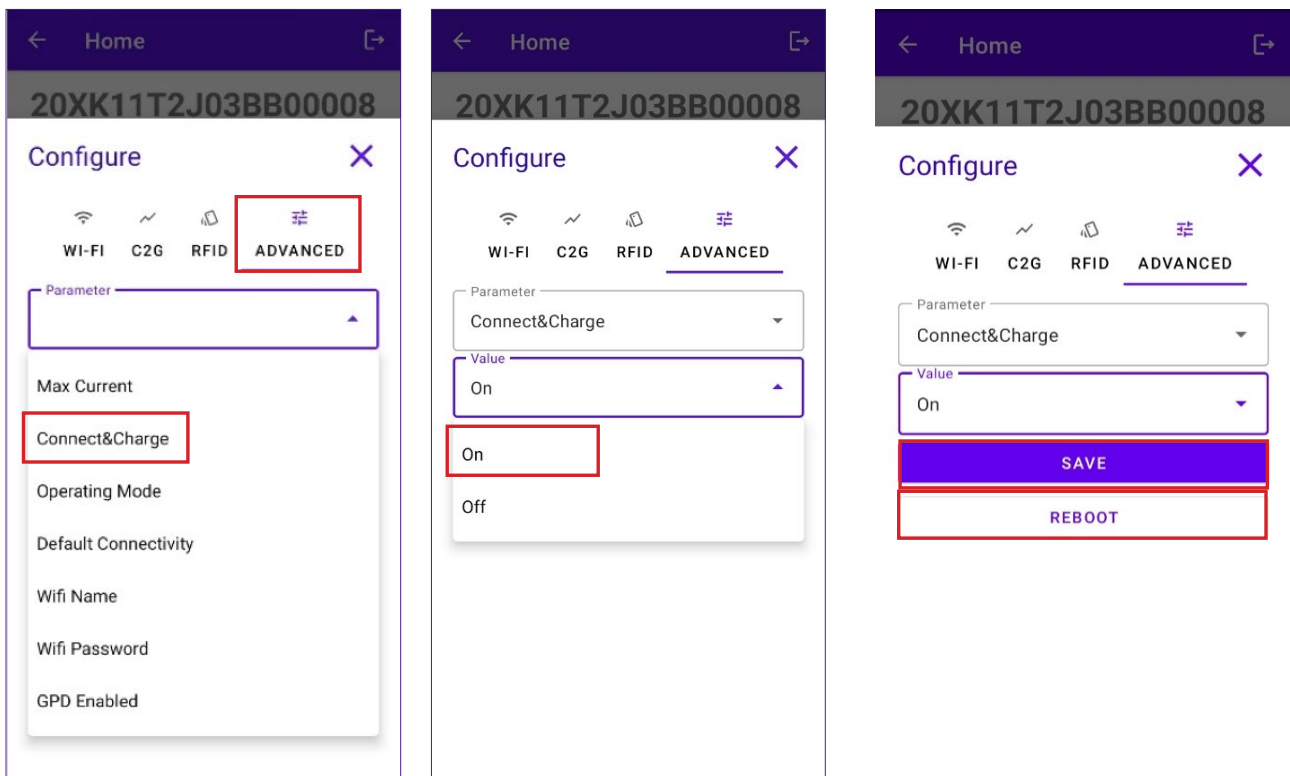

9. 5.2 MAXIMUM CURRENT CONFIGURATION

To configure the maximum current value:

1. Select the **ADVANCED** tab.
2. Select the **Max Current** tab.
3. Set the value according to the table below.

NOTE:

The maximum current selected, expressed in Amps, determines the maximum charging power that can be delivered by the Waybox.

NOTE:

The table provides power ratings corresponding to different current levels (Amperes). You can select any current value between 6 and 32 A.

	Current (Ampere)	6	8	10	12	14	16	18	20	22	24	26	28	30	32
POWER (KW)	1-PH (230 V)	1.4	1.8	2.3	2.8	3.2	3.7	4.1	4.6	5.0	5.5	6.0	6.4	6.9	7.3
	3-PH (400 V)	4.1	5.5	6.9	8.3	9.7	11.1	12.4	13.8	15.2	16.6	18.0	19.4	20.7	22.1

IMPORTANT NOTE:

if the Waybox has been previously commissioned make sure that the Waybox has been first configured in standalone operating mode (see [section 9.4](#) of this manual).

4. Click **SAVE**.
5. Click the **REBOOT** button.

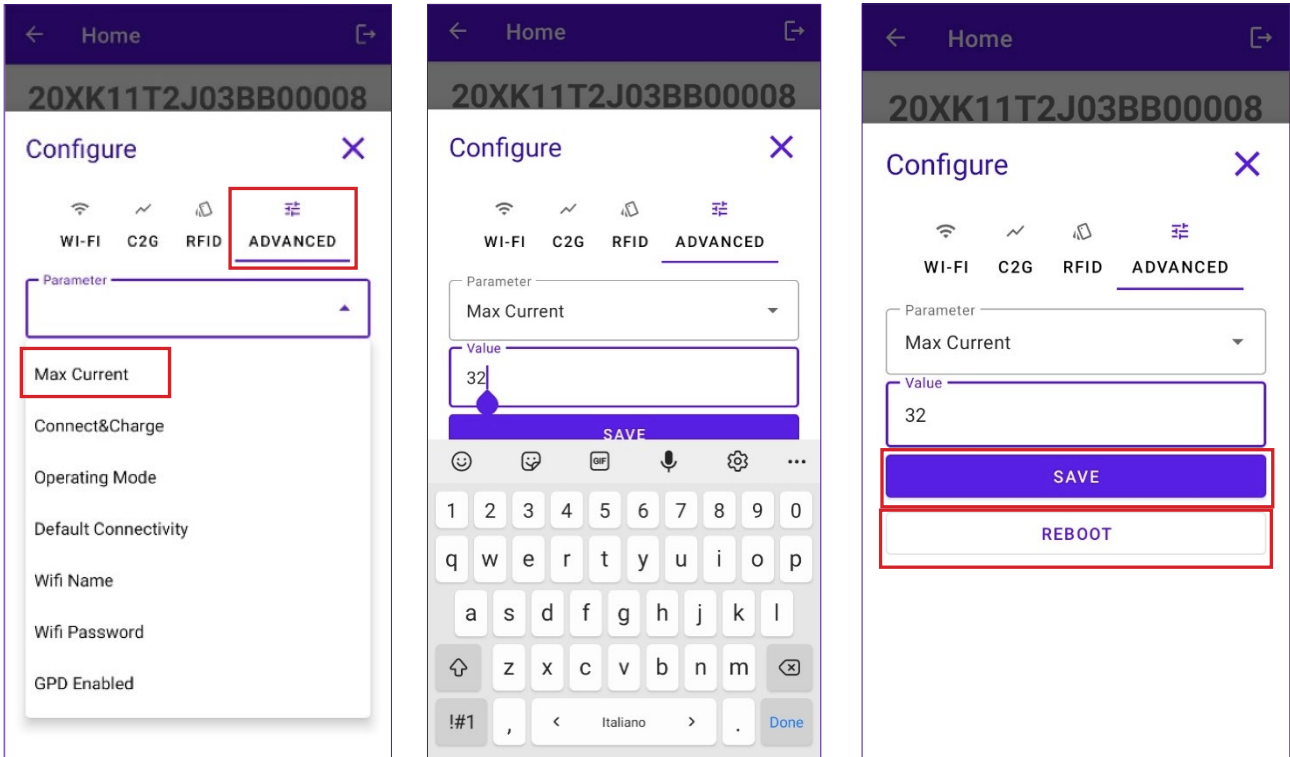

9.5.3 ADDING THE RFID CARD TO WHITELIST

1. Click on **CONFIGURATION** button;

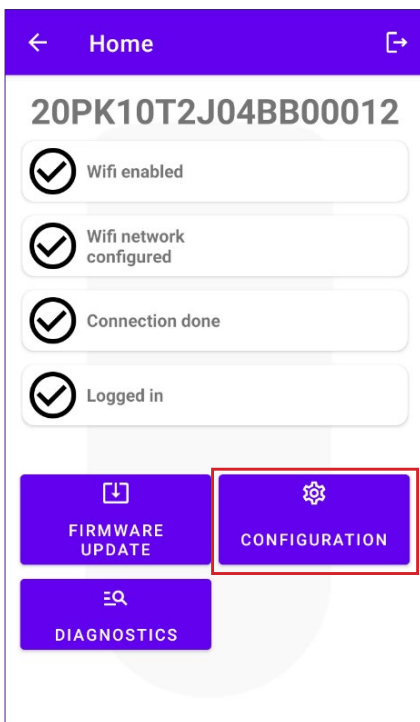

2. Select the **RFID** button.
3. Click the **ADD A RFID CARD** button.
4. Place the RFID card on the back of your phone at the NFC reader on your smartphone.

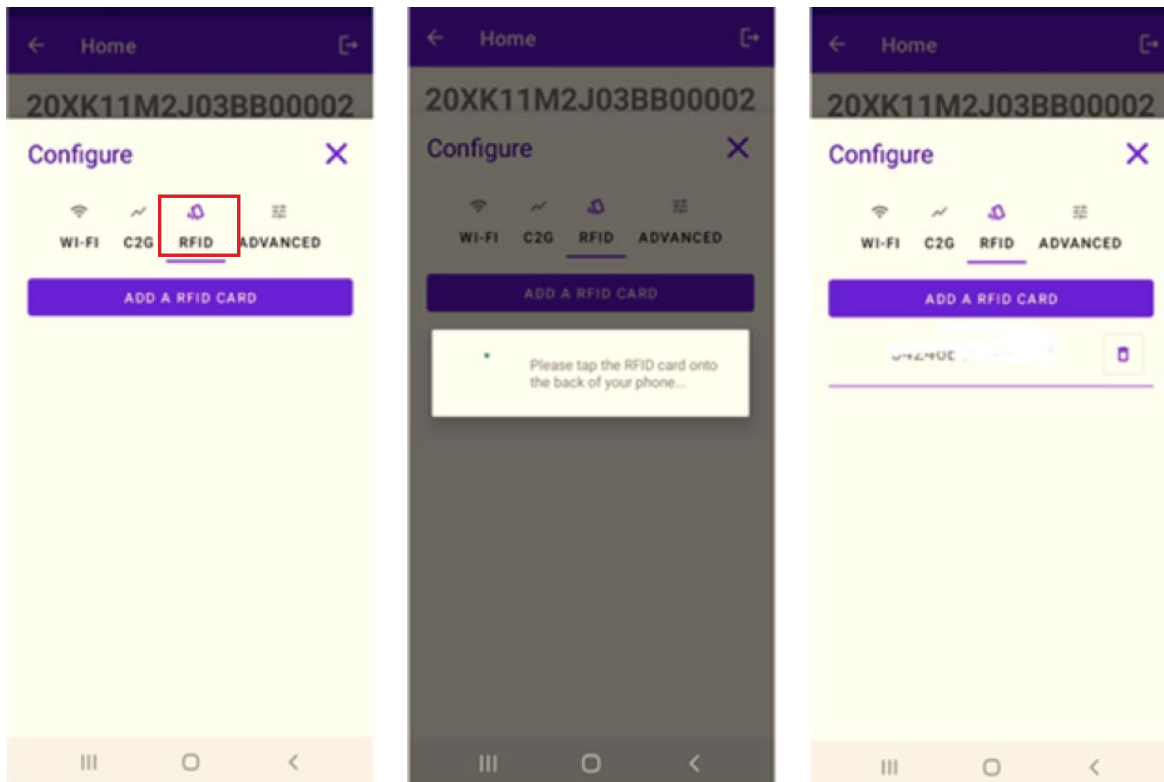

9.6 Configuration of the Waybox in case of installation on the IT network or in absence of neutral

It will be necessary to disable GPD by following the procedure in the next paragraph, if the Waybox is installed in one of the following scenarios:

- > Single-phase Waybox installed on the IT network.
- > Waybox installed on a network without neutral (for example between two phases).

9.7 GPD disabling procedure

NOTE:

This configuration is available only for JB3VUEV02c Firmware version and newer.

To disable the GPD:

1. Select the **ADVANCED** tab;
2. Select the **GPD Enabled** tab;
3. Set the value to **False**;
4. Click **SAVE**;
5. Click the **REBOOT** button.

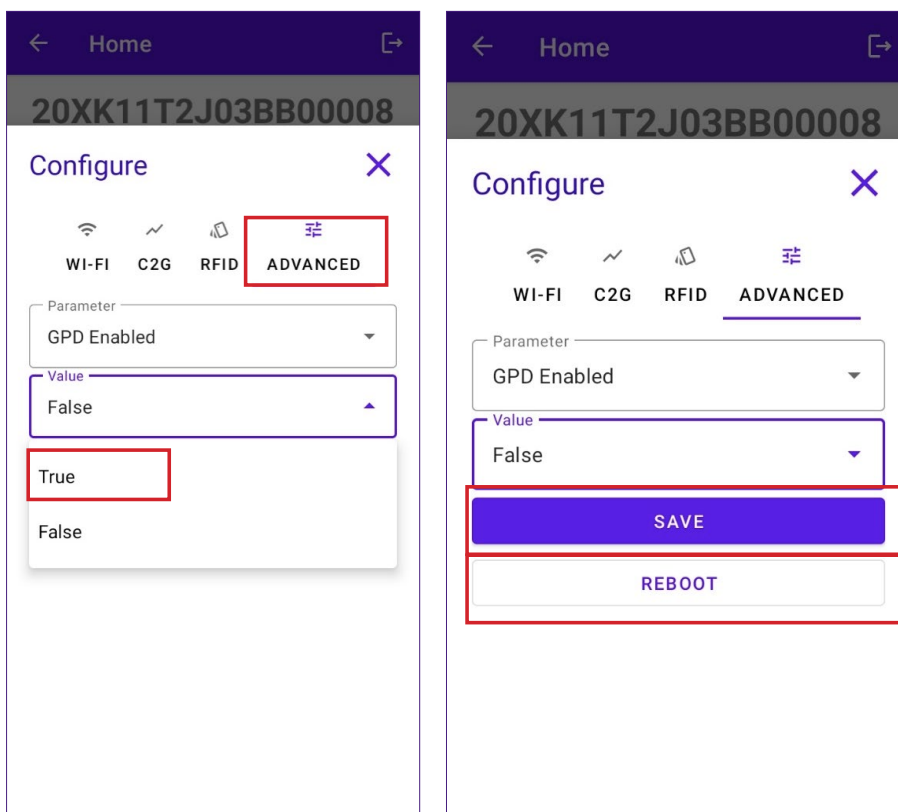

10 Viewing Waybox Diagnostics

In the **DIAGNOSTICS** section it's possible to view meter data such as current or power during the charging session.

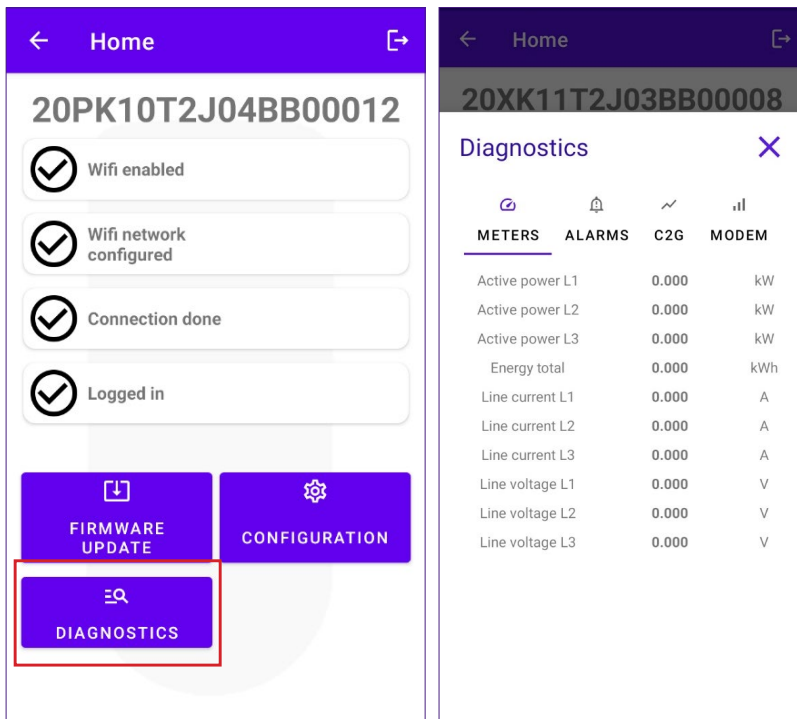

In the diagnostic section it's possible to view the alarms of the Waybox.

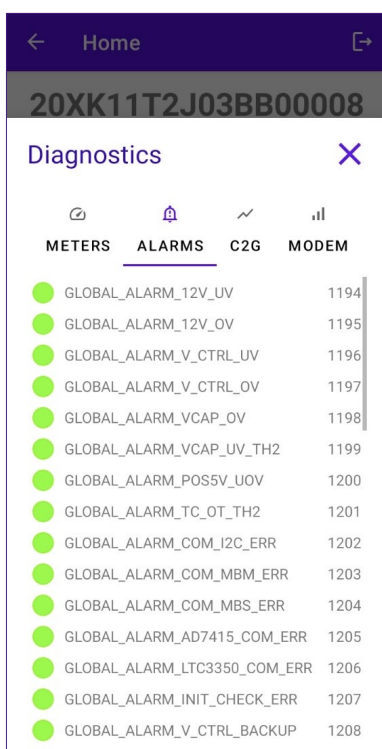

D: Web Manager manual

1 Procedure for accessing the Web Manager tool

Provide power to the Waybox to turn it on and wait approx. 30 seconds for its WiFi hotspot to activate (the hotspot will activate after a beep sound from the Waybox). The hotspot remains active for 1 minute after powering on.

1. Connect via smartphone or PC to the WiFi hotspot **“Waybox-###” with ### that corresponds to the last three digits of the Waybox’s serial number. Once connected to the WiFi hotspot, the connection remains active for 10 minutes.**
2. Access <http://10.10.10.1> through a browser to use the Web Manager tool.
3. Enter the password **000000** and click **Login**.

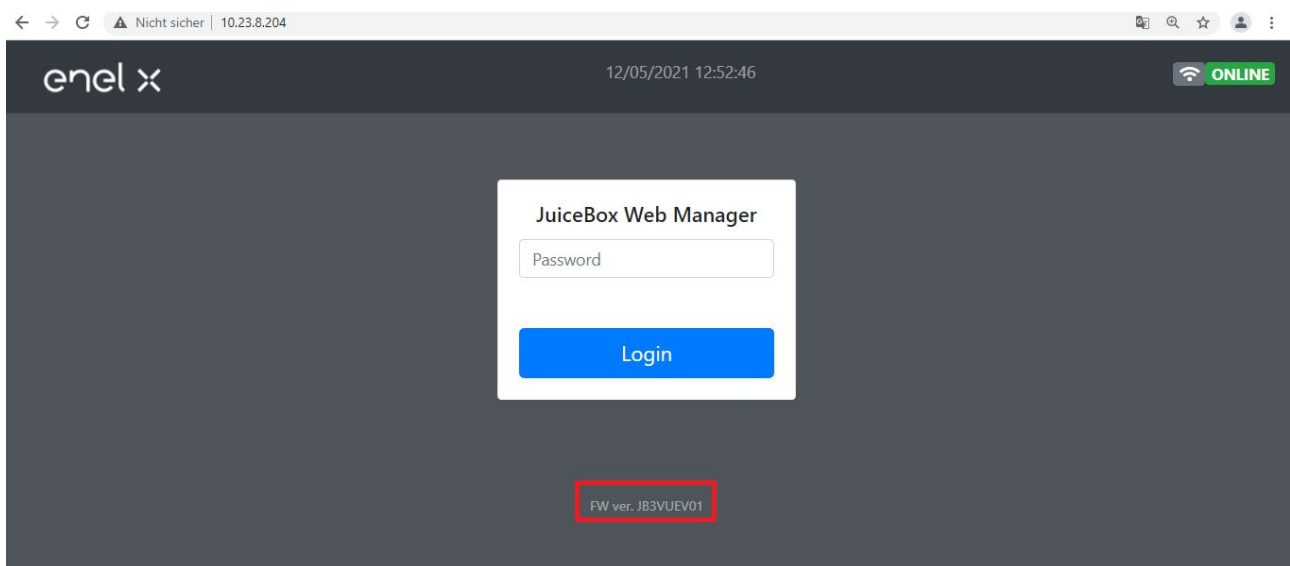

NOTE:

The firmware version of the Waybox is highlighted in the red box.

2 Procedure for setting the Waybox in “standalone” mode in case of lack of connectivity and for commissioning

NOTE:

To see the firmware version, you must connect to the WebManager tool to view the version that appears under the login fields.

“Setting the Waybox access mode, power and Supply System” is only available for firmware versions equal or higher than JB3VUEV01a. This section is necessary if Waybox are to be commissioned but cannot be connected to the internet due to lack of connectivity. If performing commissioning in the absence of connectivity for firmware versions prior to JB3VUEV01a, it is necessary to configure the Waybox in standalone mode through the following procedure:

1. Power the station in a place with cellular connectivity.
2. Contact your Enel X Way local support: specifying to set the station identified with its “standalone” serial number and requesting to make all the SW updates available.
3. Wait for a reply indicating that the activity is finished.

Following the procedure indicated above, it will be possible to set the parameters indicated in the section **“Setting the Waybox access mode, power and Supply System”**.

NOTE:

It is necessary to request to put the Waybox in standalone mode only when cellular coverage is not possible. The UnlockToCharge function will not be available in this case.

3 Setting the Waybox access mode, power, and Supply System

NOTE:

The features described in this paragraph are only available for connected Waybox from firmware version JB3VUEV01a. To view the firmware version, you must connect to the WebManager and view the version that appears below the login fields.

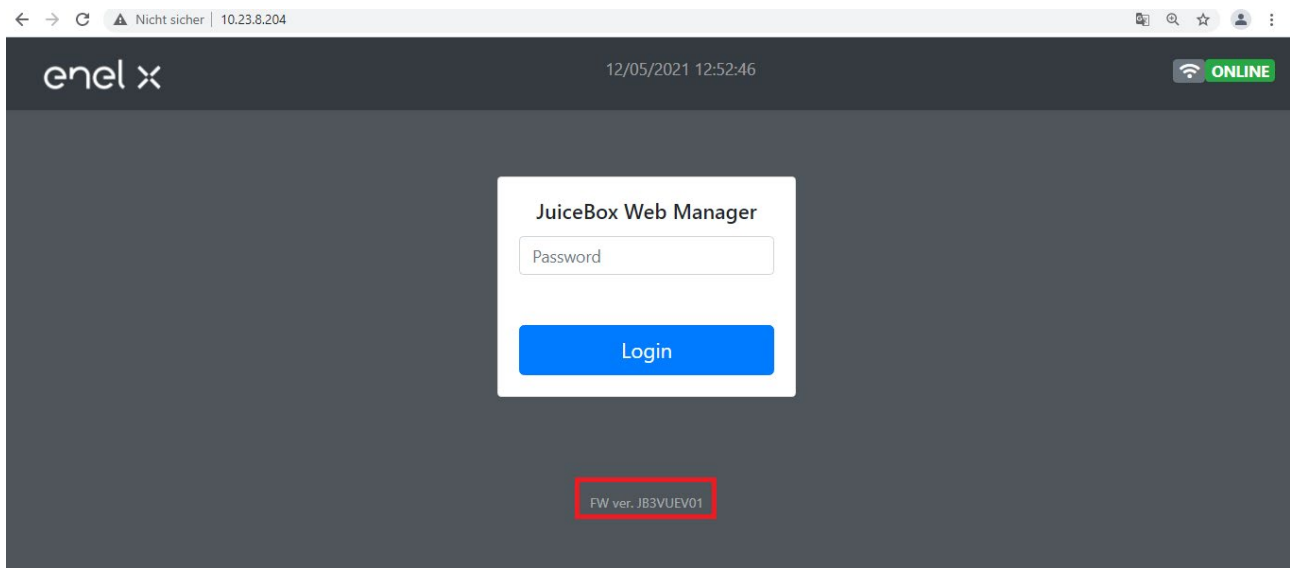

Setting the Waybox access mode and power is necessary if you do not have connectivity during installation and commissioning. If you have connectivity, setting the access mode and power must be done through the app and therefore it is possible to skip this section.

NOTE:

Make sure Waybox is updated to the latest version.

NOTE:

If the login screen does not show firmware version JB3VUEV01a (or higher) in the red box, this means that the Waybox is not updated to the latest version and therefore it is not possible to change I_{max} and access mode.

1. Access the Web Manager following **“Procedure for accessing the Web Manager tool”**
2. Select **Settings** from the quick menu on the left of the screen.

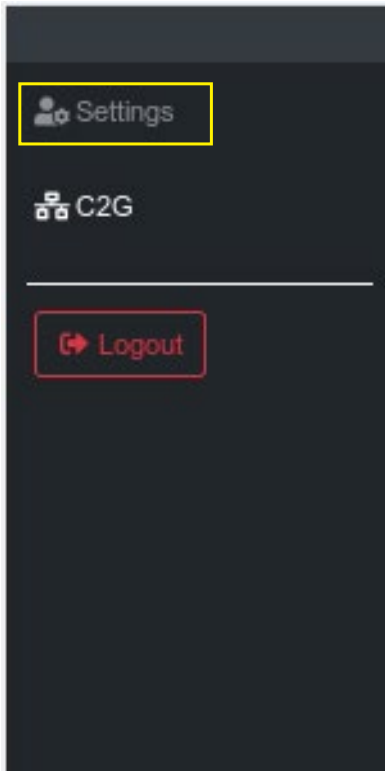

3. Access the **System** window (top left) to configure the Waybox access mode (plgch), maximum charging current (imax) and the Supply System.

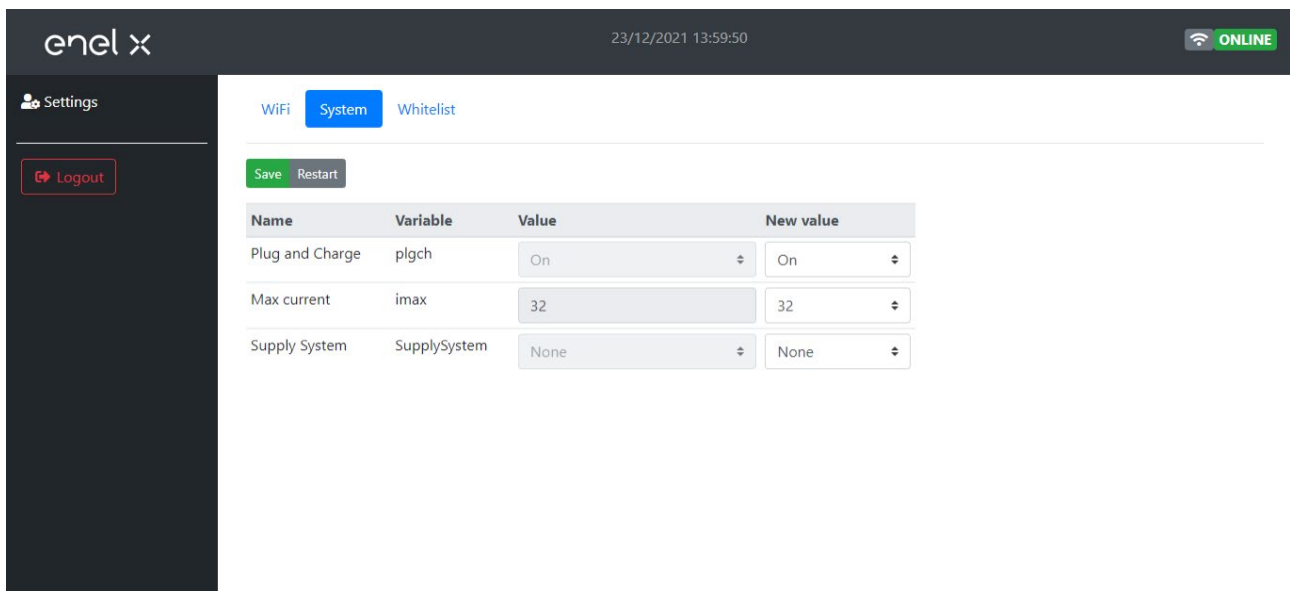

- > Waybox access mode (Connect and Charge or Plug and Charge field):
 - > Connect and Charge (or Plug and Charge) On: to start a charge simply connect Waybox to the vehicle, without any authentication.
 - > Connect and Charge (or Plug and Charge) Off: to start a charge, it is necessary to use an RFID card associated with the Waybox (if the Waybox version supports the RFID feature), or to start the charge via the App.

- > Maximum charging current (Max current field): the maximum current selected, expressed in Amperes, determines the maximum charging power that can be delivered by Waybox..

NOTE:

The table below provides power ratings corresponding to different current levels (Amperes). You can select any current value between 6 and 32 A.

	Current (Ampere)	6	8	10	12	14	16	18	20	22	24	26	28	30	32
POWER (KW)	1-PH (230 V)	1.4	1.8	2.3	2.8	3.2	3.7	4.1	4.6	5.0	5.5	6.0	6.4	6.9	7.3
	3-PH (400 V)	4.1	5.5	6.9	8.3	9.7	11.1	12.4	13.8	15.2	16.6	18.0	19.4	20.7	22.1

NOTE:

When the Waybox is commissioned via the app, the current value indicated in the I_{max} parameter of the WebManager is no longer taken into consideration. The current/power value taken into consideration is the lower of the one set in the app, the one set by the ENEL control room, the one selected via Waymeter and the Waybox rating. If, due to connectivity problems, the Waybox is offline, the current value used will be the lower of the one used in the last charge and the one communicated by the Waymeter (if C2G is active).

- > Supply System (Supply System field): this configuration must be made in case of the installation of a three-phase Waybox on a single-phase or bi-phase supply system.

Set the value to:

- > Monophase" in case of Single-phase supply system.
- > "Biphase" in case of a Bi-phase supply system.

4. When you have finished the changes, press **Save** above the settings configured in the previous point. Restart the device by powering off/on and check that parameters have been saved.

NOTE (VALID FROM FIRMWARE VERSION JB3VUEV01A):

Please note that if there is no connectivity when installing the Waybox, there is no need to request that the Waybox be set to standalone mode. The standalone mode does not allow use of the Enel X Way app and therefore it is not possible to monitor consumption. The Waybox works correctly even if it is in connected mode but not commissioned. The maximum current delivered will be that set by the I_{max} parameter. If connectivity is subsequently restored (e.g. via an external antenna), the customer will be able to carry out commissioning via the app.

4 Association of the Waybox with Waymeter

The association with a Waymeter allows the Waybox to adapt its power level based on the consumption of other devices connected to the same power line. In this way, it is possible to charge with the maximum available power while avoiding the risk of tripping the meter. Follow the steps below to associate the Waymeter with the Waybox.

1. Access the Web Manager following **“Procedure for accessing the Web Manager tool”**
2. Select **C2G** from the quick menu on the left of the screen

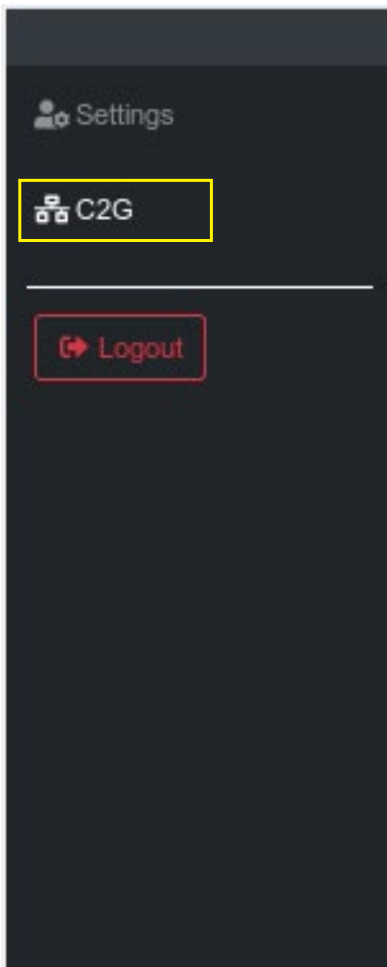

3. In the fields indicated below, enter the related parameters:

- > Model: select Waymeter from the drop-down menu.
- > Contractual Power: available contractual power of the meter to which the Waybox is connected.
- > MetID: Enter the serial ID on the meter label.



NOTE:

As an alternative to entering the MetID it is possible to enter DU and Key in the respective fields. DU and Key of the Waymeter are printed on the label inside the Waymeter packaging and are made available to the installer according to the process defined by the product supplier.

NOTE:

In the Contractual Power field, the unit of measure used is W (Watt).

Example: to enter a contractual power available of 3.3 kW, the value 3300 must be entered.

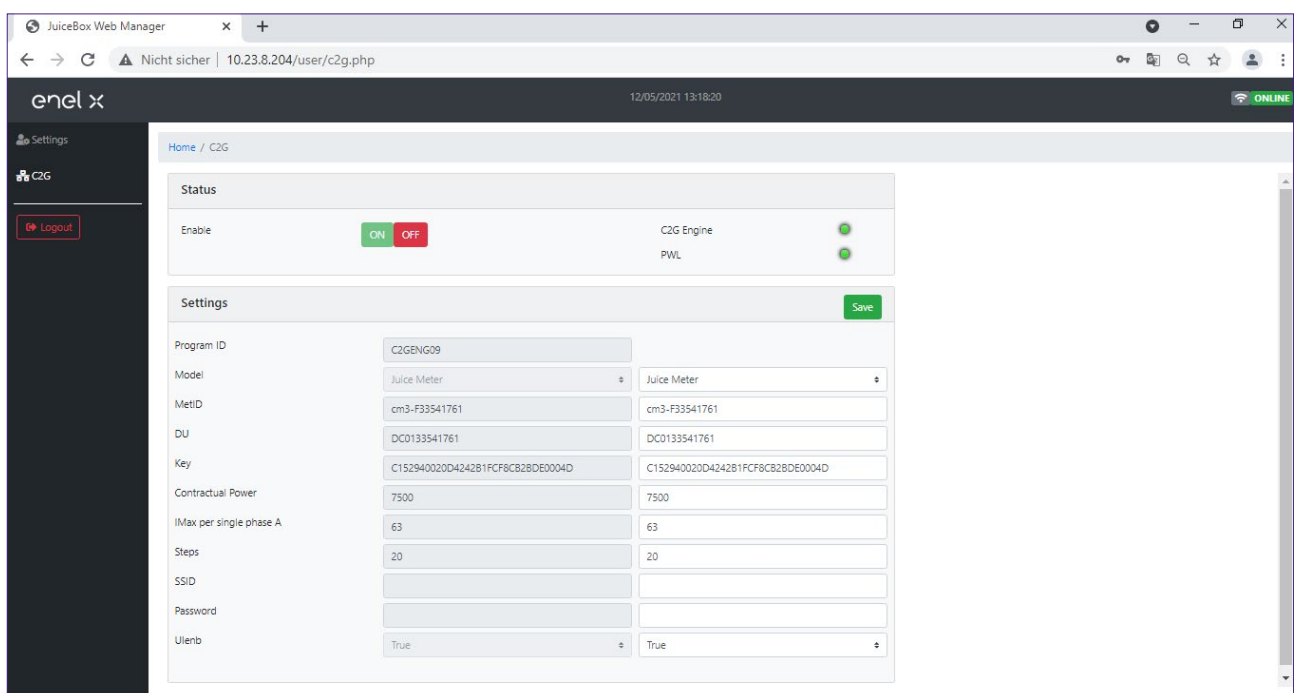

4. When you have finished the changes, press the **Save** button above the settings configured in the previous point.

5. Make sure the **Enable** field is set to **ON**.

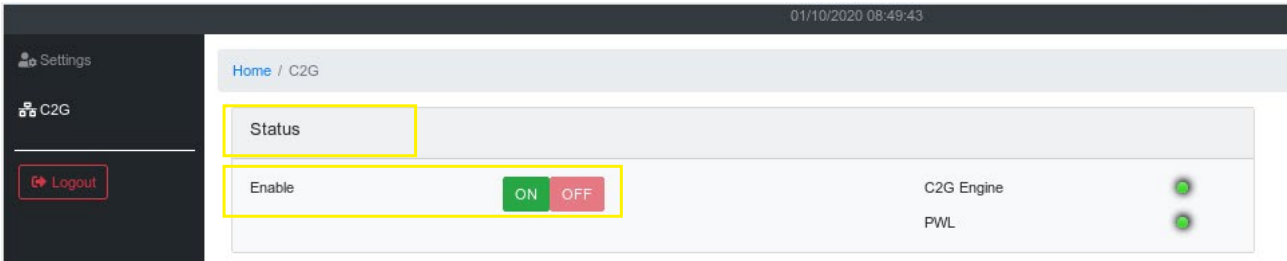

6. To verify the correctness of the configuration, make sure that the indicators **C2G Engine** and **PWL** turn green.

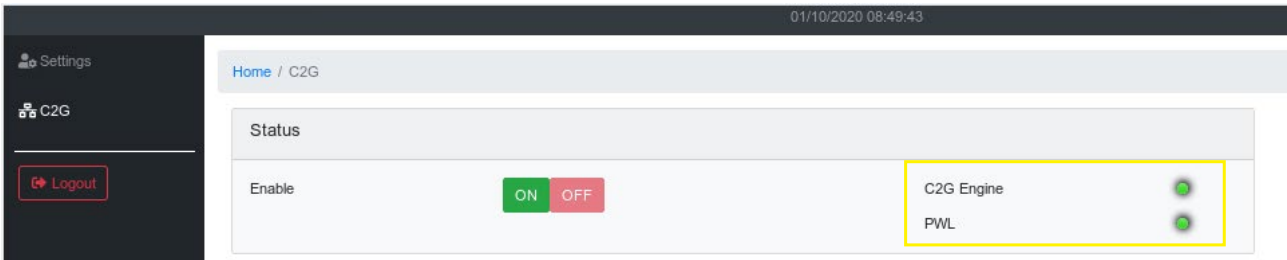

NOTE:

The C2G Engine indicator updates instantly.

NOTE:

The PWL indicator updates after the first message received from the Waymeter. The Waymeter sends messages every time the load changes, or every 15 minutes.

NOTE:

In case of Waymeter installation: on the Waymeter, the lit "service" LED indicates correct operation.

NOTE:

If a Waybox V.1 is installed but the Waymeter is not installed, the C2G functionality must be disabled.

5 Wi-Fi

NOTE:

A WiFi section appears in the Web Manager tool next to the System tab.

This section cannot be used at the moment.

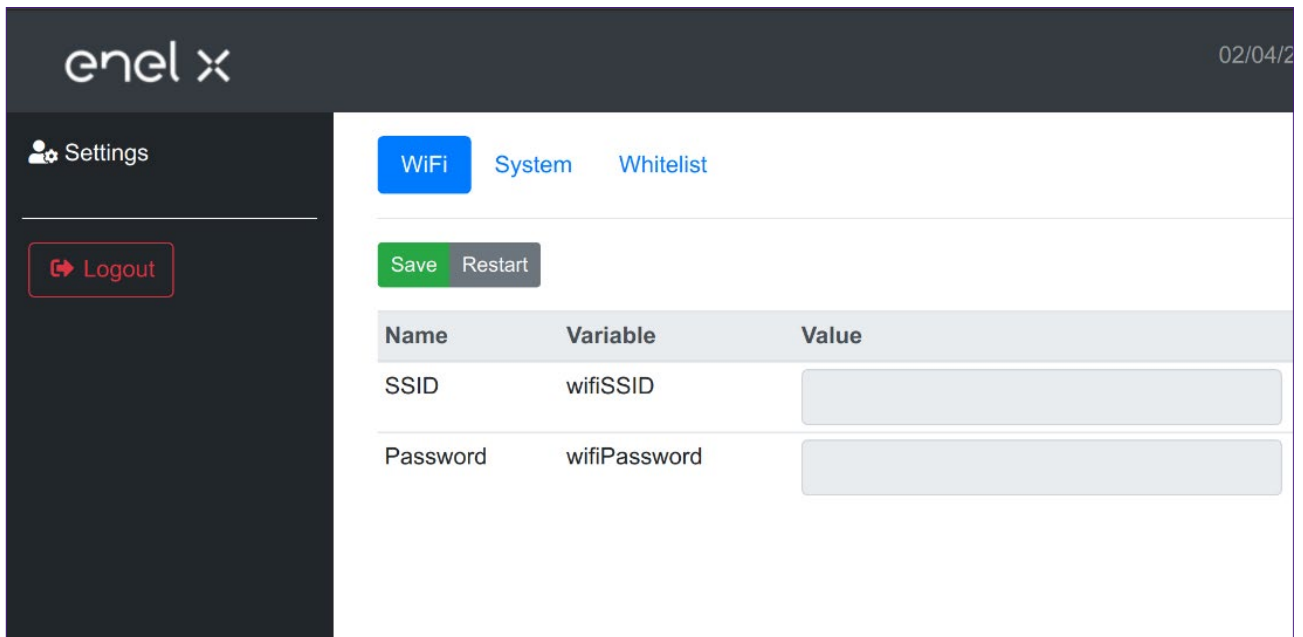

The screenshot displays the enel x Web Manager interface. The top header shows the enel x logo on the left and the date 02/04/2023 on the right. A dark sidebar on the left contains a 'Settings' menu with a gear icon and a 'Logout' button with a red arrow icon. The main content area has three tabs: 'WiFi' (active), 'System', and 'Whitelist'. Below the tabs are two buttons: a green 'Save' button and a grey 'Restart' button. A table with three columns is shown below the buttons:

Name	Variable	Value
SSID	wifiSSID	<input type="text"/>
Password	wifiPassword	<input type="text"/>

E: Procedure for installing the external protection release solution for Waybox with control board

1 Introduction

This procedure must be followed only in case a Waybox cable version installed in Italy or in Holland or a Waybox installed according to "EV ready" technical requirements.

2 Procedure for installing the external protection release solution



Remote control BASIC AC 230V



Connection cables
for motor control

Control board

1. Pay particular attention to the safety instructions and warnings in the **5ST3054** "Basic AC 230V Remote Control" product manual..
2. Proceed with the assembly of component **5ST3054** "Basic AC 230V Remote Control" as indicated in the installation manual of the component by coupling it with the magneto-thermic switch:
 - a. through adapter **5ST38202** in case of 4P switch.
 - b. through adapter **5ST38206** in case of 2P switch.
3. Proceed with product wiring by connecting the 230 VAC single-phase power supply to the "L" and "N" terminals and the 1-1.5mm² connection cables coming out of the control board to the "OFF" and "COM" terminals of the terminal block of the **5ST3054** component. The maximum length of the connecting cables between the control board and the component's terminal block is 1500 m.

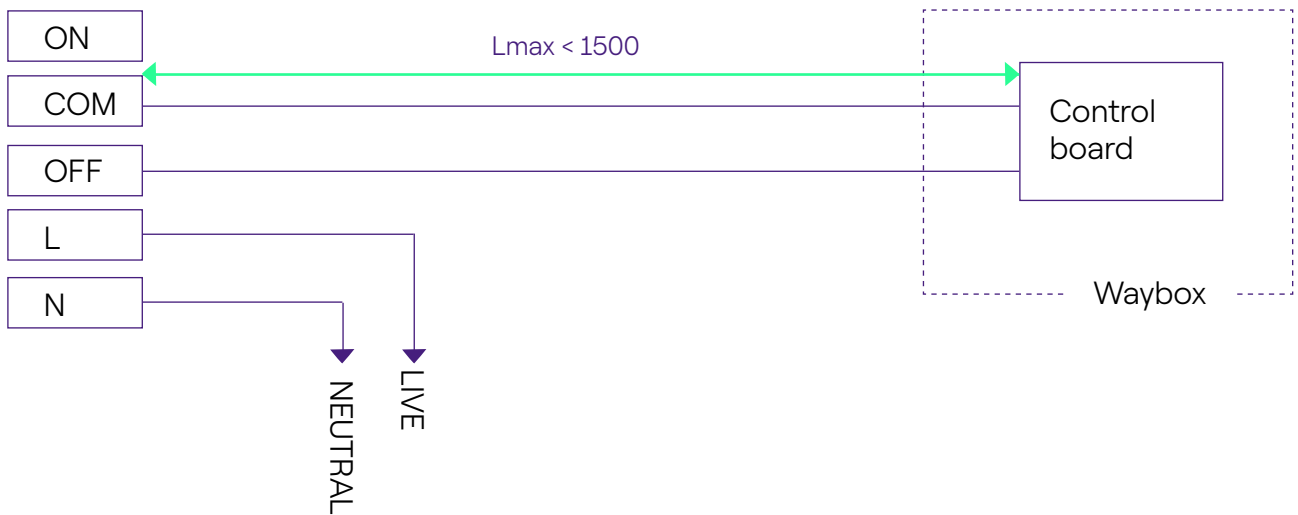

NOTE:

The power supply of the motor must be taken downstream of the protections dedicated to the Waybox.

4. Set the switch on component **5ST3054** "Basic AC 230V Remote Control" to the "RC ON" position.

3 Composition of Siemens Protection Kits

1. Waybox socket version 3.7 kW

CODE	COMPONENT
5SL42207	Magnetothermic switch 10 kA, 2-pole, C-curve, 20A
5SM23236	Pure Residual Current Device Id=0.03 A, 2-pole, type A, 40 A

2. Waybox cable version and Waybox socket version with control board 3.7 kW

CODE	COMPONENT
5SL42207	Magnetothermic switch 10 kA, 2-pole, C-curve, 20A
5SM23236	Pure Residual Current Device Id=0.03 A, 2-pole, type A, 40 A
5ST3054	Modular motor control BASIC version for 5SY, 5SL
5ST38206	Motor control adapter for 5SL 2P

3. Waybox socket version 7.4 kW

CODE	COMPONENT
5SL42407	Magnetothermic switch 10 kA, 2-pole, C-curve, 40A
5SM23236	Pure Residual Current Device Id=0.03 A, 2-pole, type A, 40 A

4. Waybox cable version and Waybox socket version with control board 7.4 kW

CODE	COMPONENT
5SL42407	Magnetothermic switch 10 kA, 2-pole, C-curve, 40A
5SM23236	Pure Residual Current Device Id=0.03 A, 2-pole, type A, 40 A

5ST3054	Modular motor control BASIC version for 5SY, 5SL
5ST38206	Motor control adapter for 5SL 2P

5. Waybox socket version 22 kW

CODE	COMPONENT
5SL44407	Magnetothermic switch 10 kA, 4-pole, C-curve, 40A
5SM23436	Pure Residual Current Device Id=0.03 A, 4-pole, type A, 40 A

6. Waybox cable version and Waybox socket version with control board 22 kW

CODE	COMPONENT
5SL44407	Magnetothermic switch 10 kA, 4-pole, C-curve, 40A
5SM23436	Pure Residual Current Device Id=0.03 A, 4-pole, type A, 40 A
5ST3054	Modular motor control BASIC version for 5SY, 5SL
5ST38207	Motor control adapter for 5SL 4P

F: What-if Manual - Special installation cases

1 Purpose of the Manual and Method

This **What-if manual** brings together the most frequent particular cases and is a useful aid for quick and intuitive orientation towards the most suitable solution. For each special case, the best procedure to follow, the additional material required, the relevant section of the installation manual or its annex are indicated.

The installation manual, the installer checklist, the Web Manager procedure, the Enel X Way app user procedure, the JB4installers app, the GPD deactivation procedure, the training sessions, the video tutorials and any other official document provided by Enel X Way remain the main and indispensable source of information even for standard cases.

This **What-if manual** is based on **two simple logical steps**:

- > **The verification of a context condition** (e.g. no connection) useful to identify the particular case.
- > **A binary question** (the only possible answers are Yes or No) to identify the solution.

Then the arrows will indicate which operations to carry out, which manual/document to consult for details, which additional tools or materials to use.

2 List of Special Installation Cases

The following are the contextual conditions that determine a special installation case.

1. Data network with SIM is insufficient (valid for Waybox Plus Cellular and Waybox Pro Cellular).
2. Single-phase IT power grid.
3. Customer smartphone connectivity not adequate.
4. Lockable garage with shutter (or other type) that weakens signal.
5. Single-phase TT/TN power grid.
6. Three-phase TT/TN power grid.
7. Single-phase TT electrical network without neutral.
8. Waybox with control board in Italy and in Holland.
9. EV Ready installation.
10. Waybox with Load Optimization Pro (without photovoltaics).
11. Waybox with Load Optimization Pro (with photovoltaics).
12. Customer's vehicle not available during installation.
13. Renault Zoe, Smart 22 kW, Twingo Electric.
14. Load Optimization Pro with transformer.

The relevant procedure to be followed for each of the special cases of installation is described in the following paragraphs.

2.1 Data network signal with SIM is insufficient

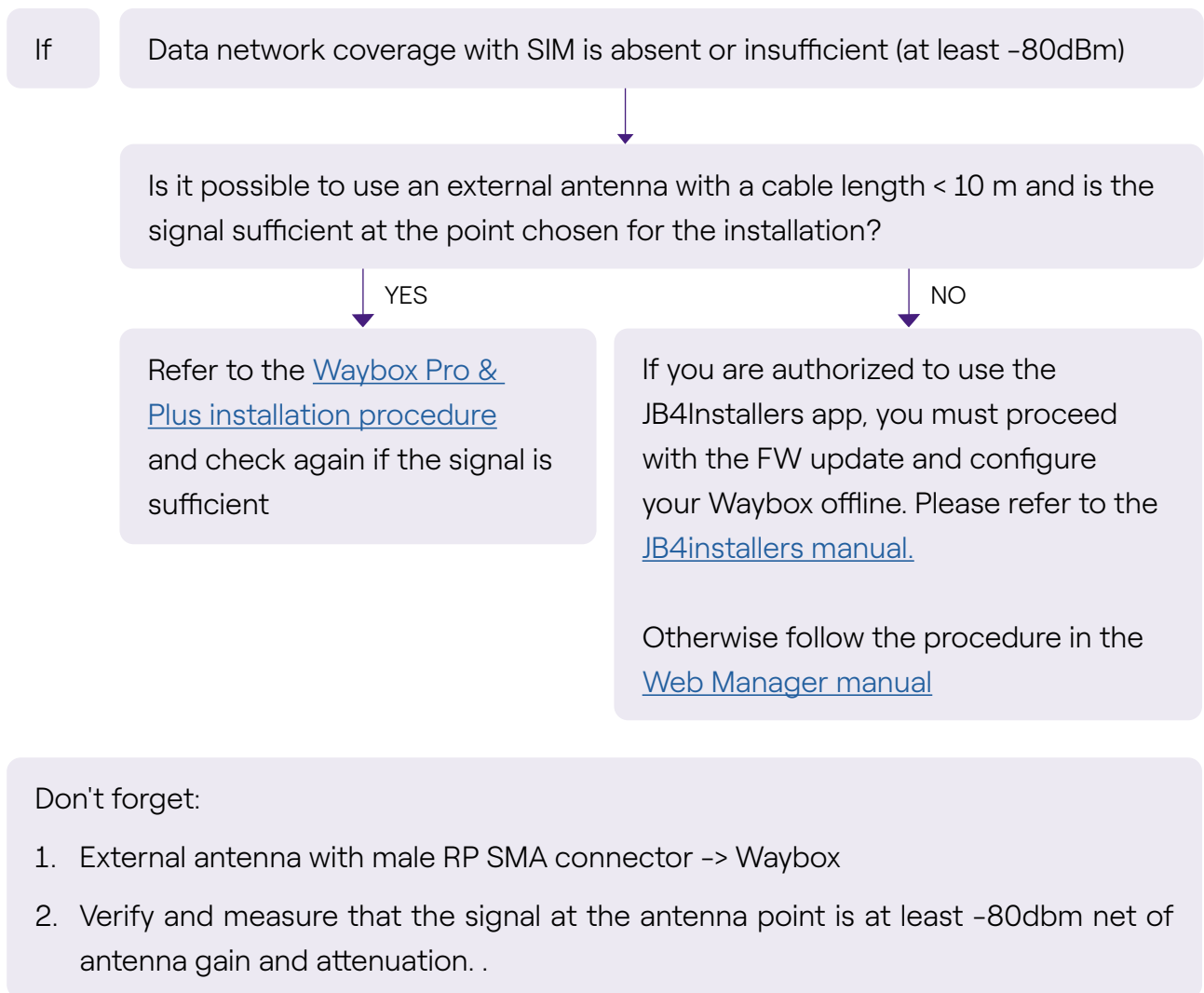

2.2 Single-phase IT power grid

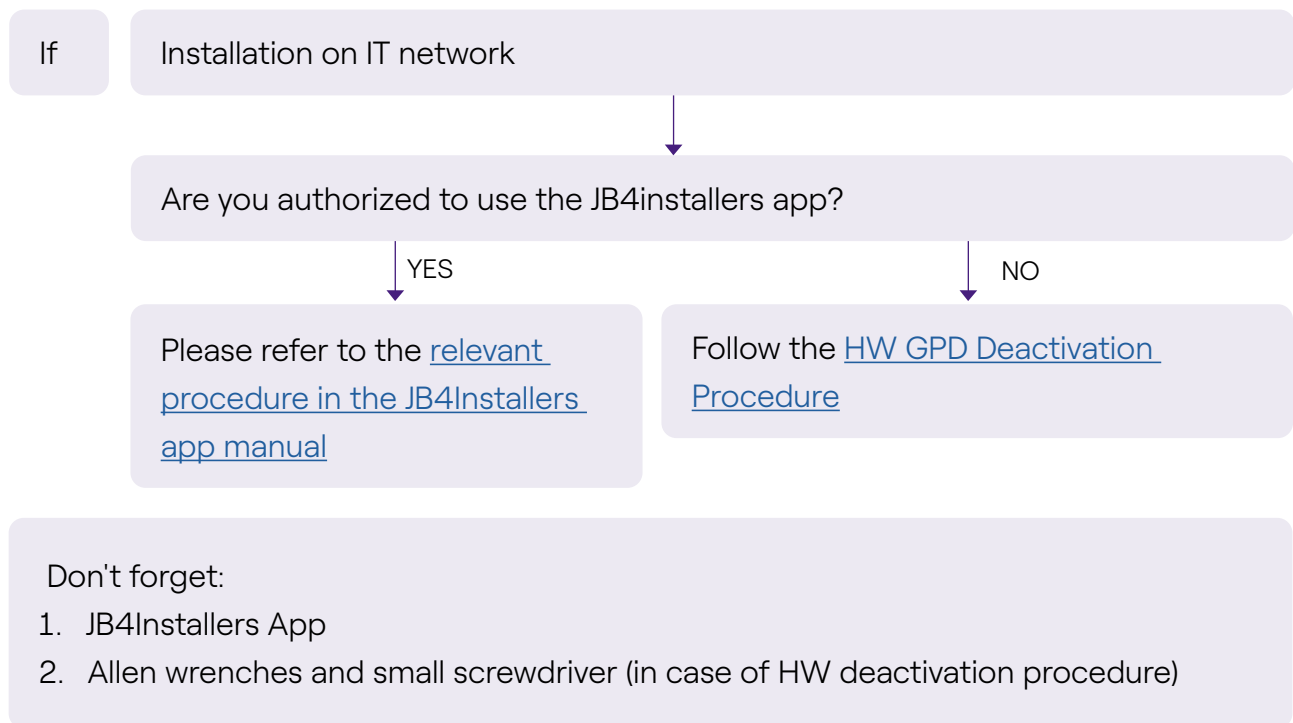

2.3 Customer smartphone connectivity not adequate

If

Waybox has sufficient connectivity, but the smartphone does not have sufficient connectivity

Is there an area with good smartphone connectivity in the immediate vicinity of the Waybox?

YES

The Customer, with the support of the installer, will be able to proceed with the commissioning of the Waybox through its serial number and the Enel X Way app, configuring the access mode and the maximum current (see the [Waybox commissioning through Enel X Way app](#) paragraph in the installation manual). The Customer will later be able to configure the access mode and maximum charging power as desired.

NO

Commission the Waybox using its serial number and Enel X Way app in an area away from the Waybox where there is connectivity. In this case, charging tests can be performed in Connect&Charge at maximum current. The Customer will later be able to configure the access mode and maximum charging power as desired. If the Customer's smartphone does not have connectivity in the immediate vicinity of the Waybox, the Customer will not be able to start charging from the app, but only by RFID card or in Connect&Charge mode.

Don't forget:

1. Make sure you can move to an area covered by data connection
2. Enel X Way App
3. Waybox serial number

2.4 Lockable garage with shutter (or other type) that weakens signal

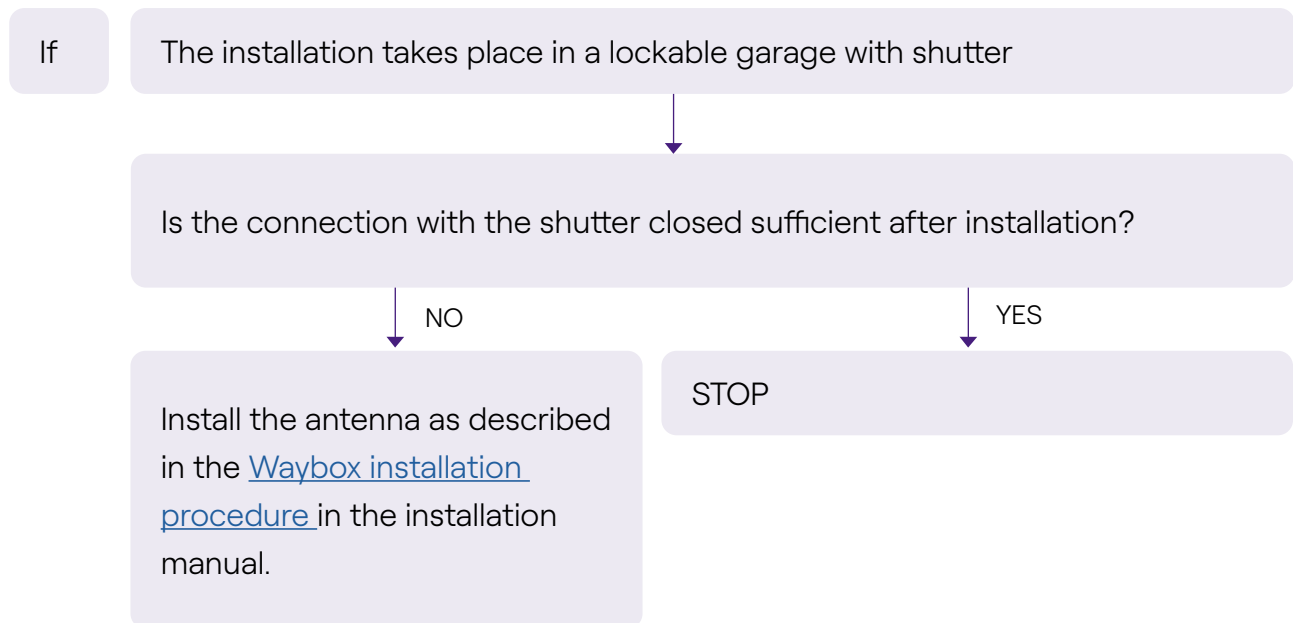

Don't forget:

1. Follow the steps for the no coverage and antenna installation procedure

2.5 Single-phase TT/TN power grid

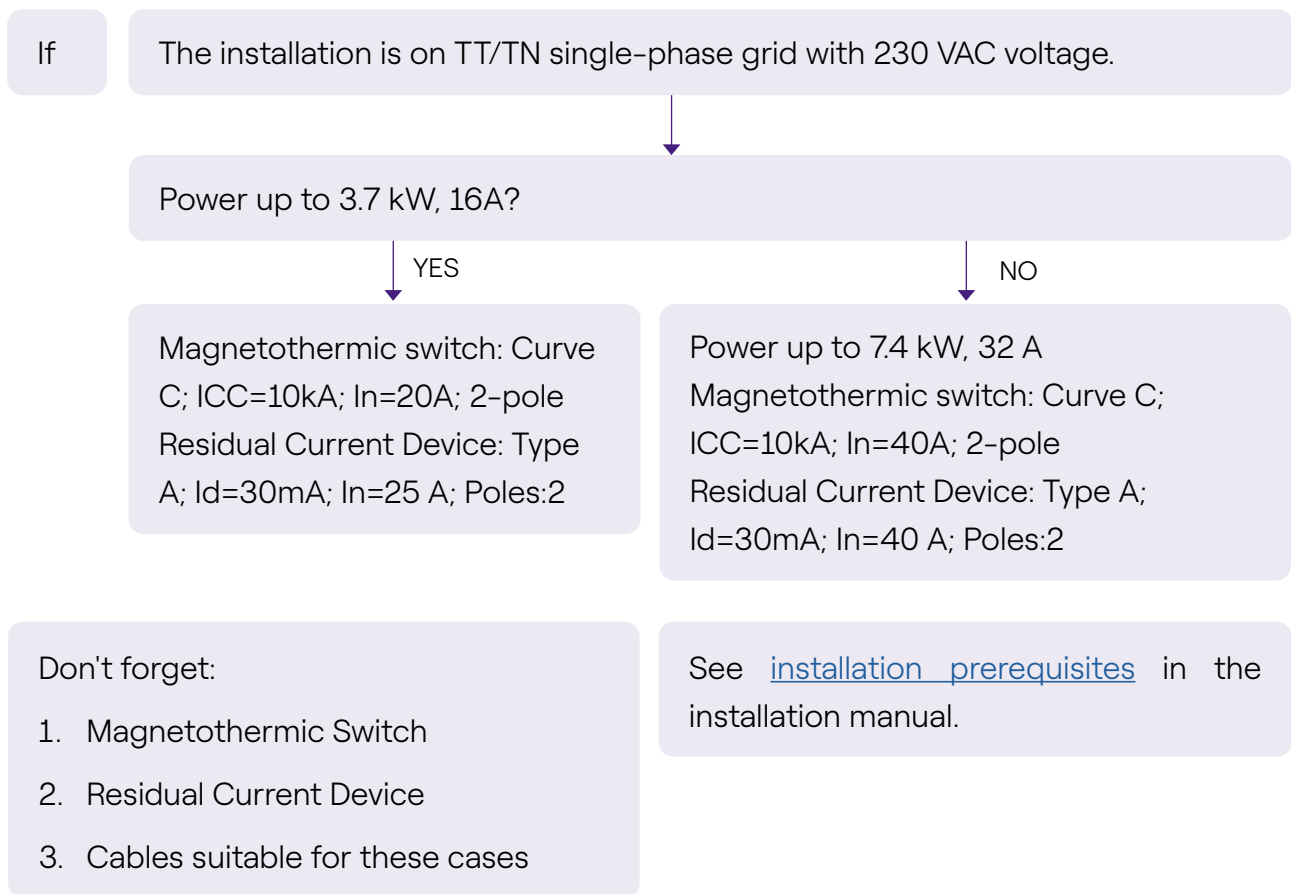

2.6 Three-phase TT/TN power grid

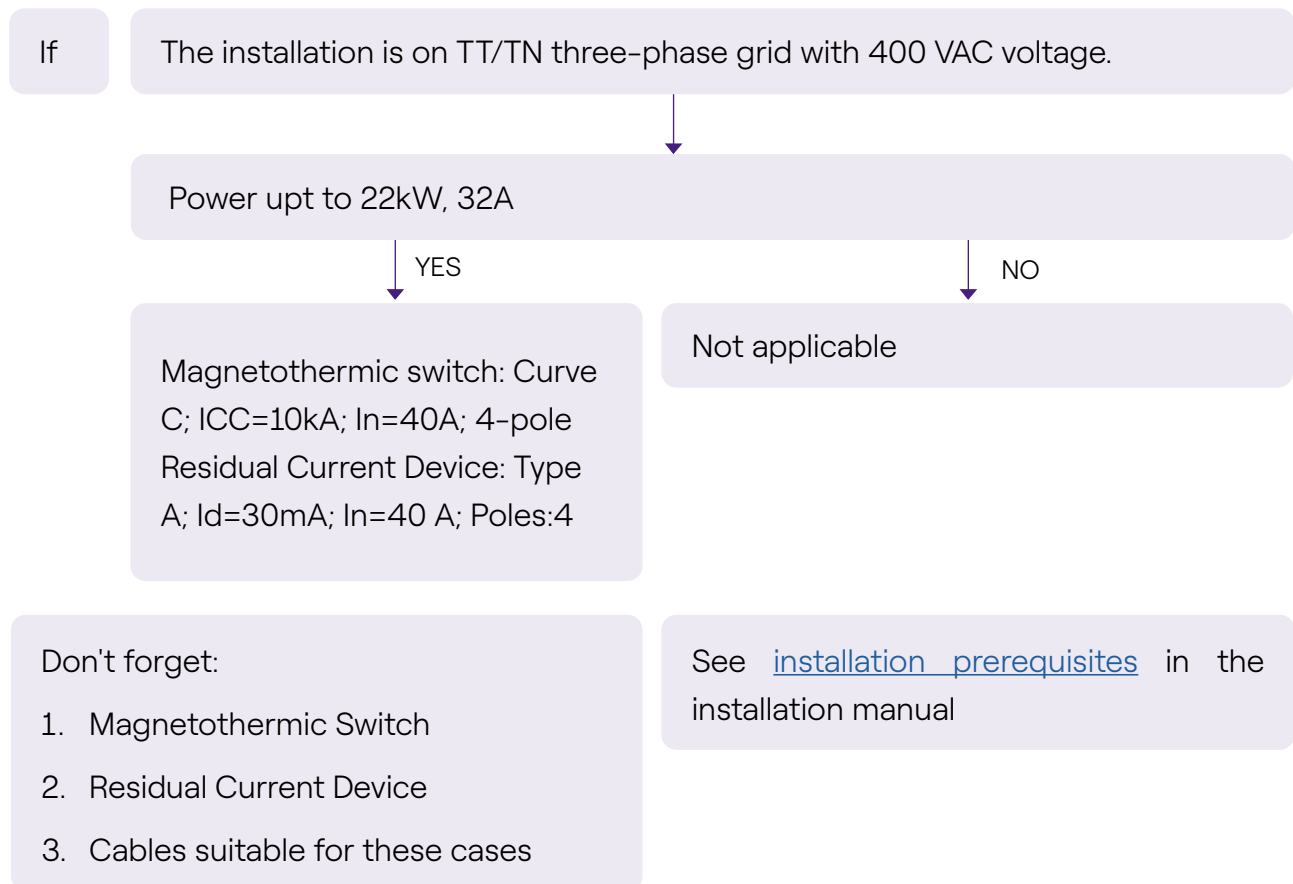

2.7 Single-phase TT electrical grid without neutral

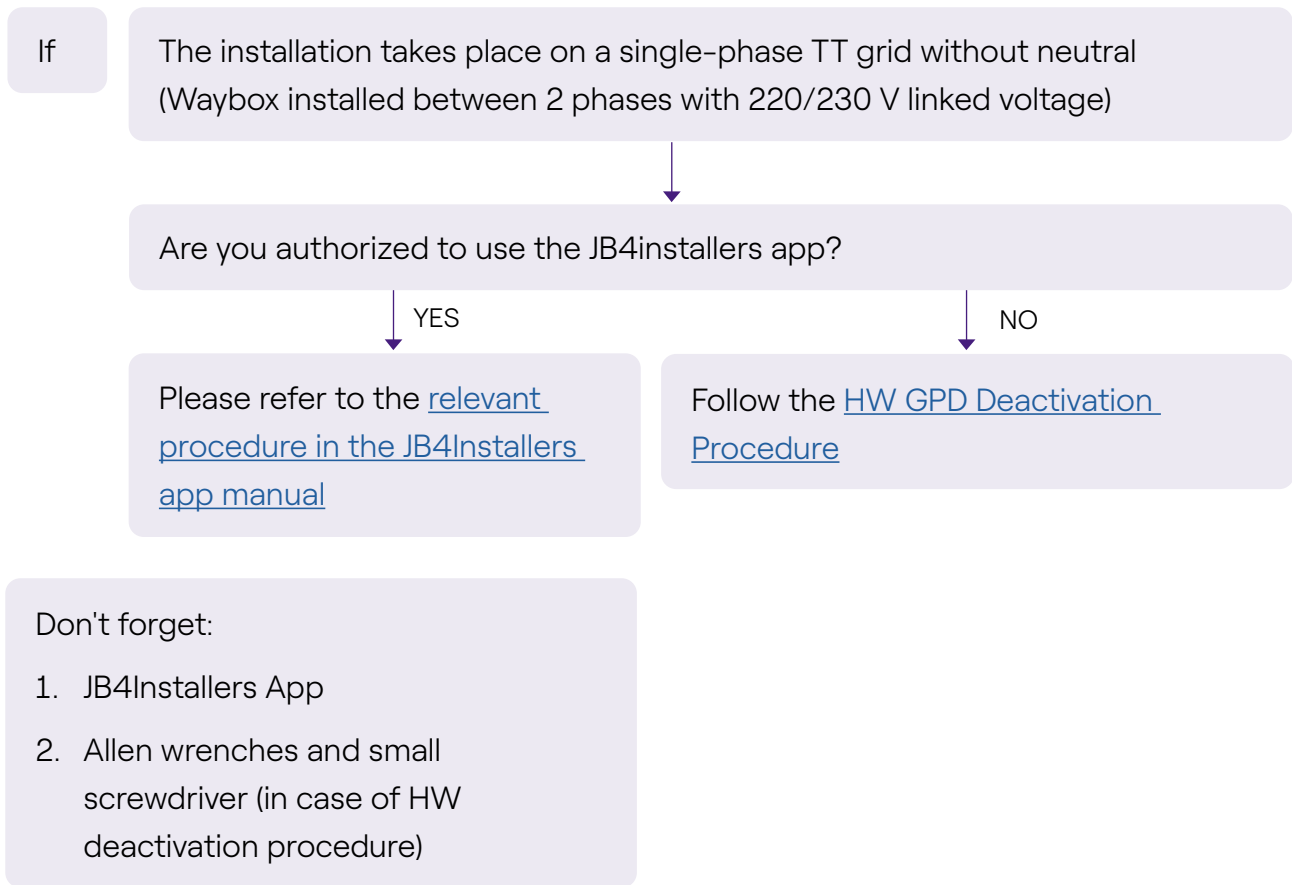

2.8 Waybox with control board in Italy and in Holland



2.9 EV ready Installation

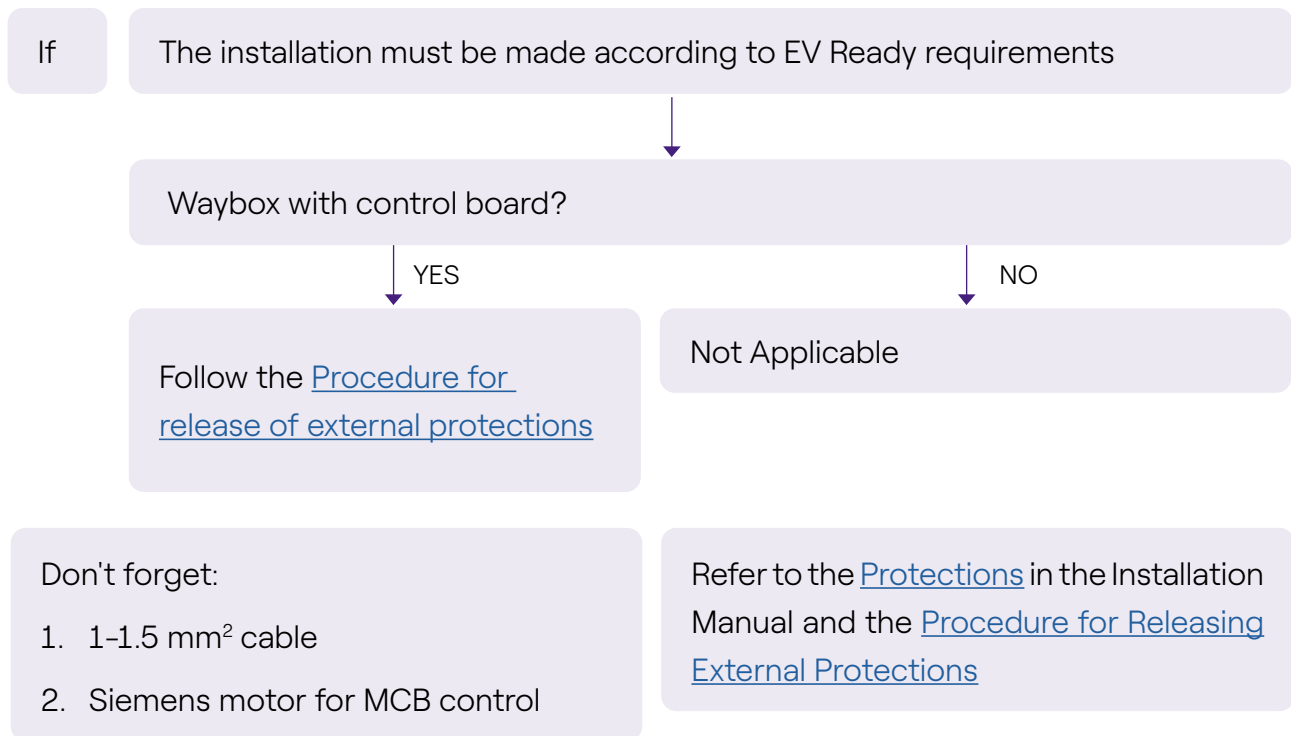

2.10 Waybox with Load Optimization Pro (without photovoltaics)

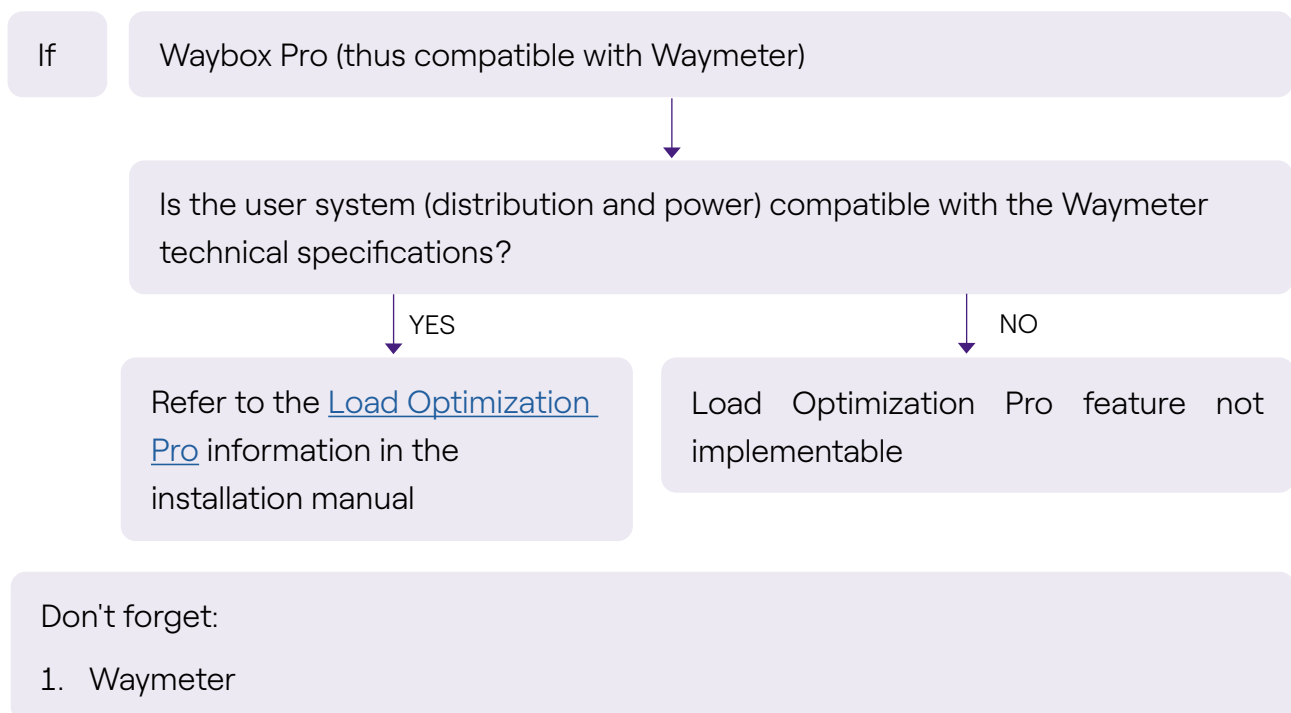

2.11 Waybox with Load Optimization Pro (with photovoltaics)

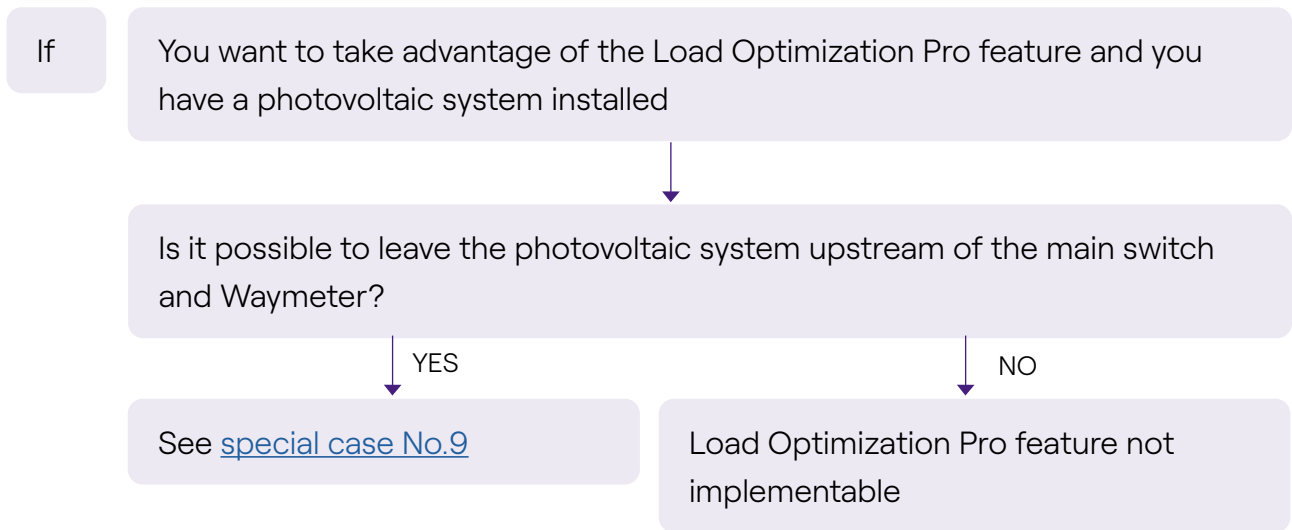

Don't forget:

1. Waymeter

2.12 Customer's vehicle not available during installation

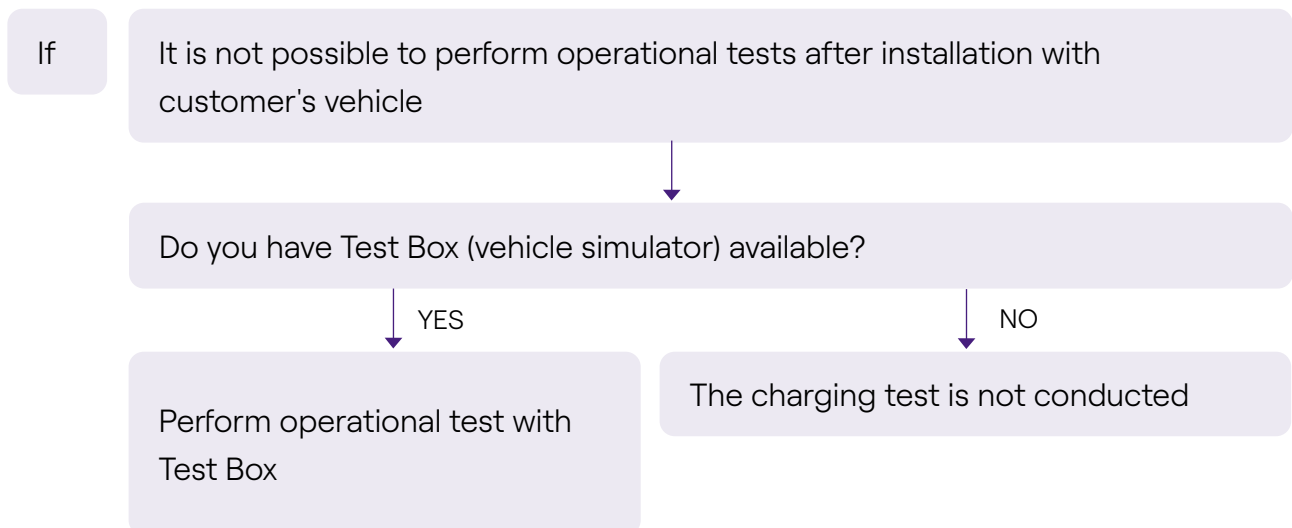

See the [Charging Test](#) section of the installation manual

2.13 Renault Zoe, Smart 22 kW, Twingo Electric

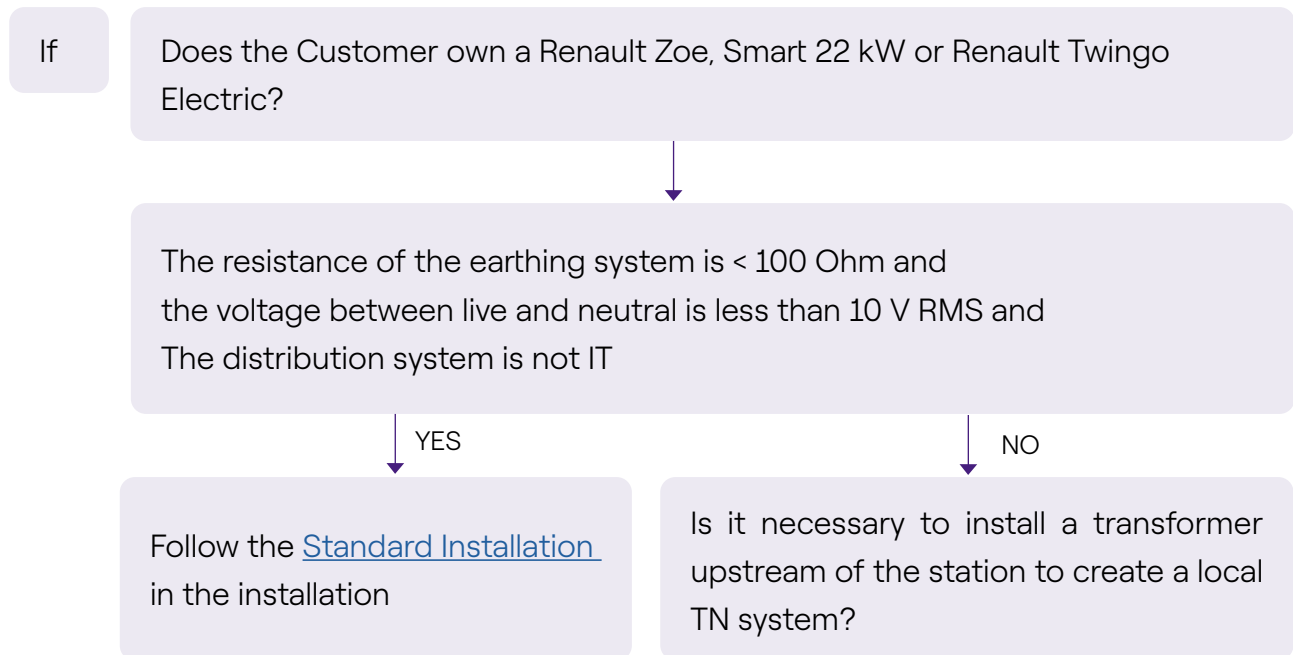

2.14 Load Optimization Pro with transformer

